



# INDUSTRIAL SOLUTIONS

## LAUNDRY

Rev.0623

info@ayvaz.com | www.ayvaz.com



## LAUNDRY

---

Energy is getting more important day by day. According to the diminishing of energy sources, industries searching for alternative sources for increasing the productivity.

In boilers, dryers, heat exchangers, iron heaters, washing machines or any other processes energy efficiency can be 25-30% higher according to application investments with low redemption times.

In this case steam getting more important. Trapping steam and more heat usage depends on the correct steam equipment selection. Although steam traps look simple and small, their mission is very complex.

Saving more energy is related to the right chosen steam equipment and sizes. Working principles should be known well for choosing the right steam equipment for the process.

As Ayvaz, we are working for produce best quality steam equipment in our factory in Istanbul in order to help our customers and the users to get the most efficiency from their steam systems.

We aimed to explain our audit experiences and technical knowledge to partners and introduce different type of steam applications and all related products with details in this catalogue.

## WASHING MACHINE

---

### WASHING MACHINE

#### OPERATING PROCESS

The solvent used in the washing machines must be heated before being sprayed onto the laundry. This process is costly when done with electricity. Steam is supplied to the solvent heating units of the washing machines. The condensate that will be formed from the solvent mixing steam of the washing machines cannot be reused. For this reason, only the entrances of the washing machines have a steam trap group.

#### STEAM USAGE

25-400 kg/h Steam Usage  
1-7 BAR Working Pressure  
120-140 C Working Temperature

#### WASHING MACHINE TYPES

Conventional textile washing and spinning machines barrier type hygienic washing and squeezing machines tunnel type washing and squeezing machines.





**EQUIPMENT NEEDS**

- Thermodynamic Steam Trap (main line)
- Bellow Sealed Valve
- Strainer
- Checkvalve

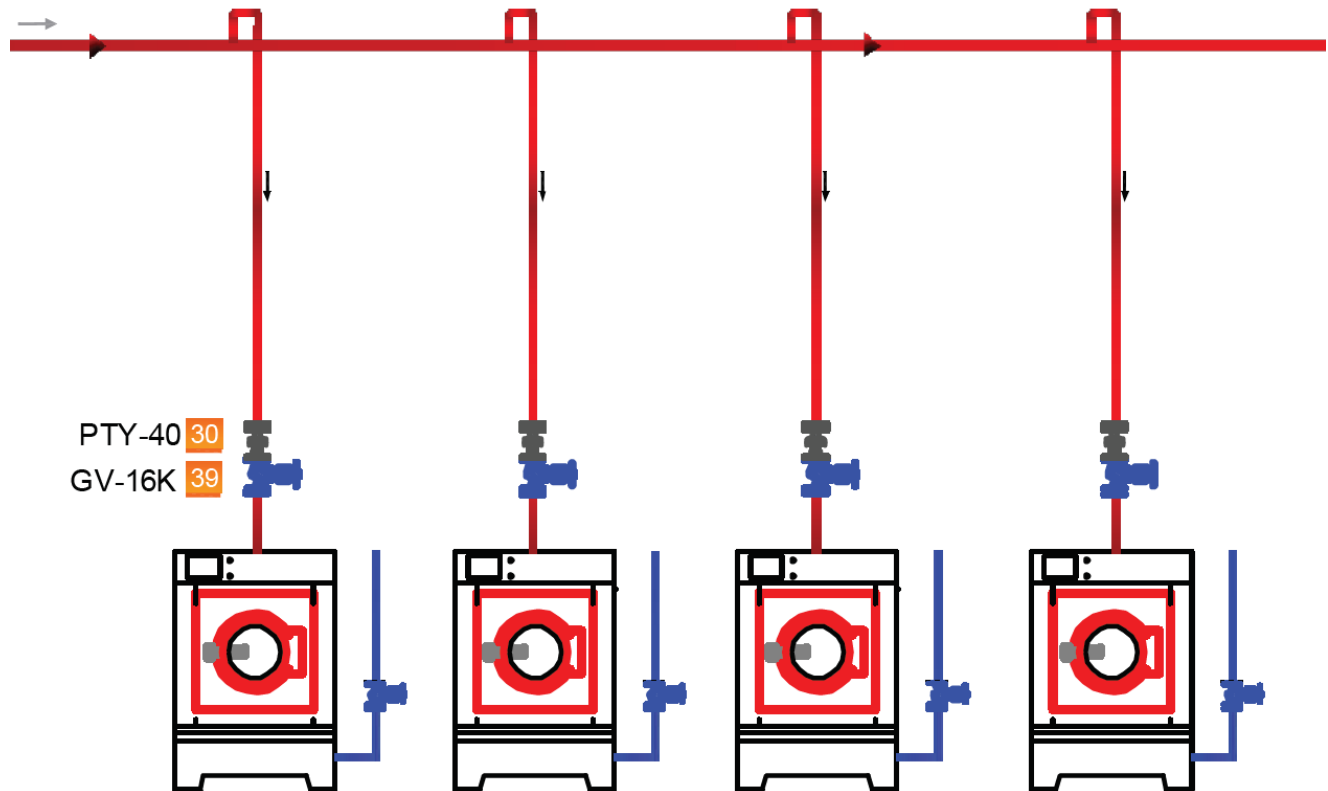

## WATER DRAGGING IN STEAM LINES - DRYERS

---

### DRYERS

#### OPERATING PROCESS

They are used for drying the laundry which does not need to be ironed or which needs to be pre-dried before ironing. Various capacities are available with single doors, separate loading and unloading doors or tilting models. They are electrically heated, steam or gas heated and their drums are stainless steel or galvanized. The working principles are the drying of the laundry by hot air circulation while the laundry rotates in the drum.

#### STEAM USAGE

25-400 kg/h Steam Usage  
1-7 BAR working pressure  
120-140 C Working Temperature

#### DRYER TYPES

Tumble Dryers  
Tunnel Type Dryers  
Cylndric Dryers



**EQUIPMENT NEEDS**

- Thermodynamic Steam Trap (main line)
- Float Type Steam Trap
- Bellow Sealed Valve
- Strainer
- Checkvalve
- Stainless Steel Flexible Metal Hoses

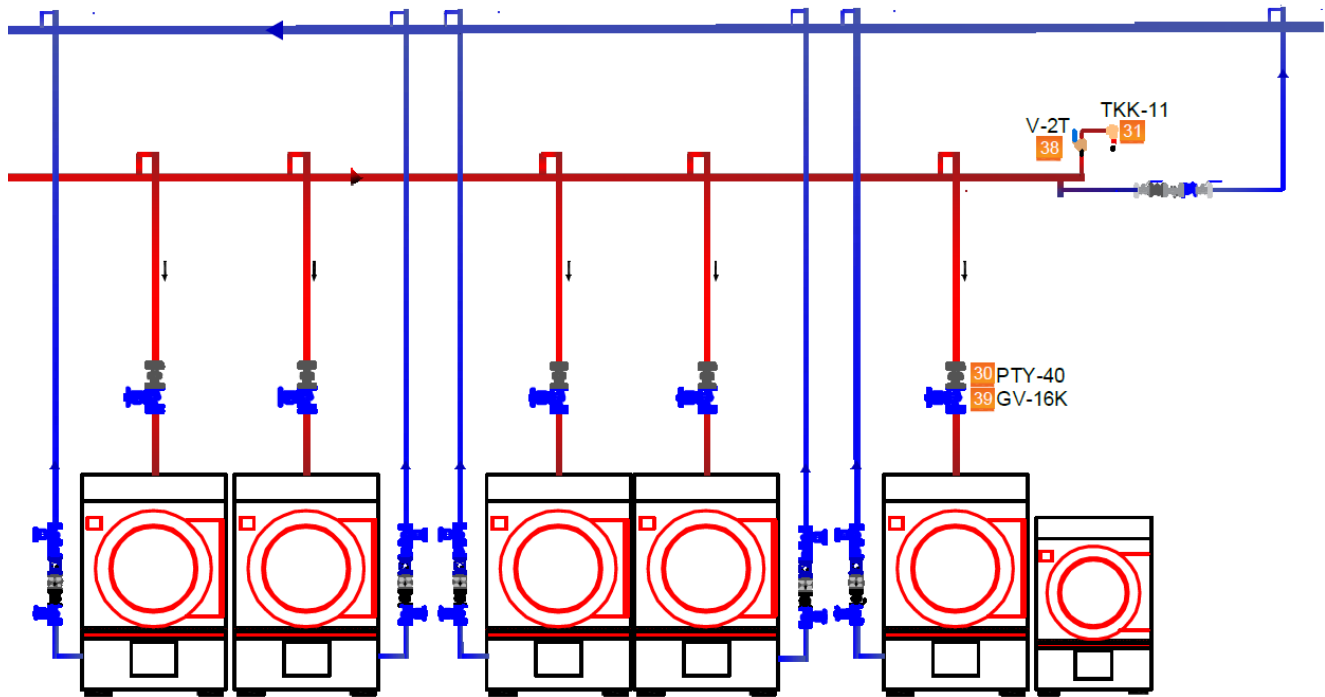

## **STEAM USAGE IN LAUNDRY - IRONING**

### IRONING

#### **STEAM USAGE**

25-35 kg/h Steam Usage  
4-5 BAR working pressure  
150-160 C Working Temperature

#### **IRON TYPES**

Cylinder Irons  
Roller Folding Machines  
Roller Folding / Ironing, Feeding Machines  
Finishing Irons  
Model Irons  
Blowers  
Iron Robots



**EQUIPMENT NEEDS**

Thermodynamic Steam Trap

Bellow Sealed Valve

Strainer

Checkvalve

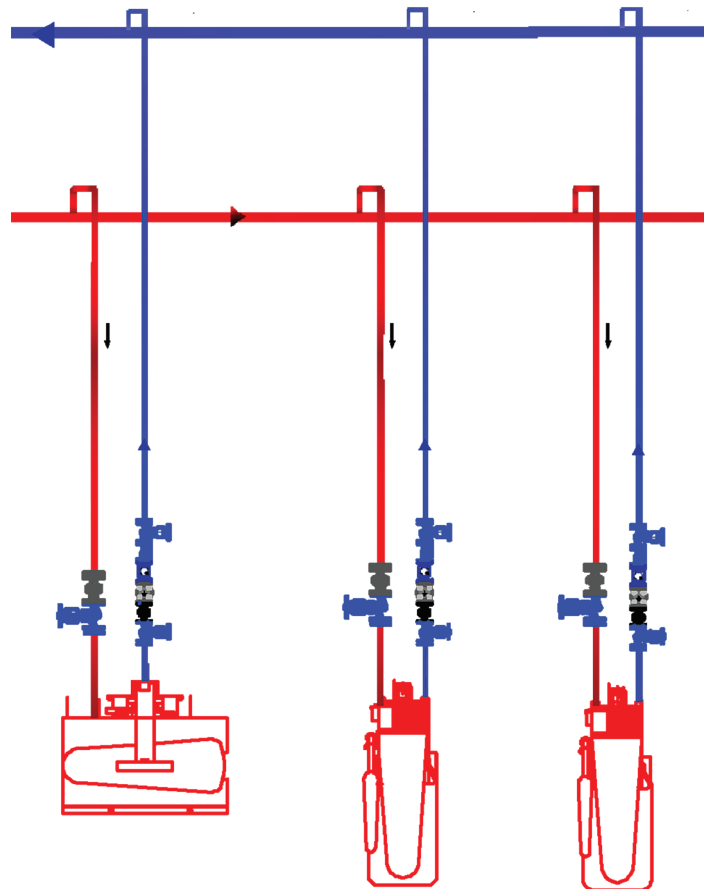



## CONDENSATION AMOUNT

TEXTILE INDUSTRY STANDARD MACHINE INFORMATION			STEAM CONSUMPTION (kg/h)		
TYPE OF DEVICE OR PROCESS	STEAM PRESSURE (bar)	CAPACITY	CLOSED COND. SYSTEM	OPEN COND. SYSTEM	
LAUNDRY MACHINES	4,0 - 5,0	Stain Removal Machine	5		
		Dry Cleaner	1 kg of Clothes	0,5	
		Laundry	20 kg of Clothes	21	25
			40 kg of Clothes	30	35
			60 kg of Clothes	43	50
			100 kg of Clothes	68	80
			150 kg of Clothes	85	100
			300 kg of Clothes	102	120
DRYING MACHINES	4,0 - 5,0	20 kg of Clothes	21	25	
		30 kg of Clothes	30	35	
		40 kg of Clothes	38	45	
		60 kg of Clothes	55	65	
		100 kg of Clothes	94	110	
		150 kg of Clothes	136	160	
		160 kg of Clothes	340	400	
INDUSTRIEL IRONS	4,0 - 5,0	Steam Irons	5		
		Trousers Press	25		
		Robot Irons	30		
		Model Blower	30		
		Trousers Blower	35		
		Cylinder Iron	50 kg of Clothes	26	30
		Cylinder Iron	75 kg of Clothes	34	40
		Cylinder Iron		51	60
Cylinder Iron		85	100		

## STEAM SEPARATOR SYSTEMS

In some cases, saturated steam may distribute directly with single line from boiler. That distribution may cause water draggings at system start up. To prevent that problem, separator systems must be installed directly to the steam lines.

In cases where dry and clean steam is required, branch line should be connected to the machine and process with a steam separator. This will help to collect the water at the bottom of the separator and to be discharged from the steam trap.

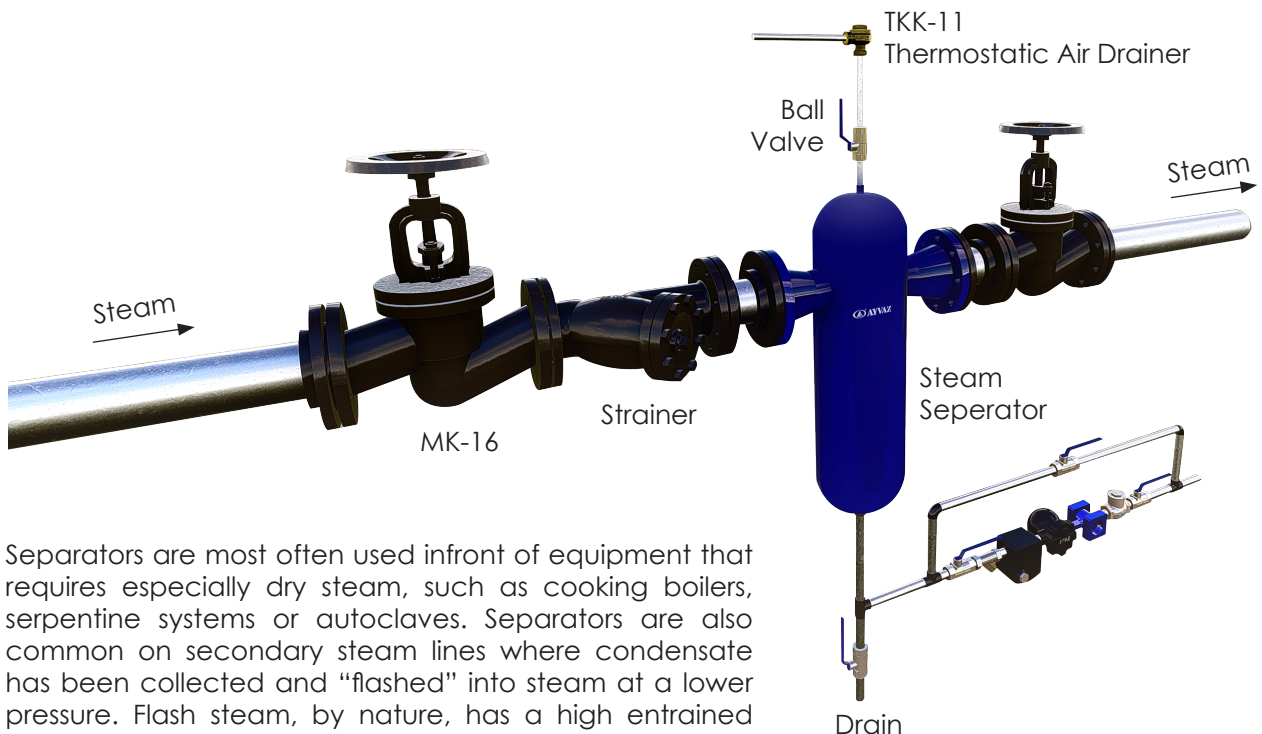

Separators are most often used in front of equipment that requires especially dry steam, such as cooking boilers, serpentine systems or autoclaves. Separators are also common on secondary steam lines where condensate has been collected and “flashed” into steam at a lower pressure. Flash steam, by nature, has a high entrained condensate content.

## CONDENSATE PUMP SYSTEM

Condensate comes from the input collector and goes on internal pipe and access check valve than enter in condensate pump body so tank is getting full. In tank when the condensate comes on the upper limit, ELK-2 level gauge check the conductivity and change it to electrical signal and send it to 3 way pneumatic valve for the giving contact which is on the steam line than allows it to be opened. In normally steam has more high pressure than the condensate pressure. When 3 way valve is close, system discharge condensate from the system with thermodynamic steam trap.

When the condensate pressure is smaller than the opposite pressure in condensate pump, discharge operation do not occur. Steam is occurs the condensate discharging with entering the body, which have more pressure than the opposite pressure. When the condensate limit is getting bottom limit of the tank, ELK-2 level gauge send electrical signal to 3-way pneumatic valve for close the system for entering steam. After that condens enter again and getting full tank . This operation frequency is connect between the condensate quantity. If the users want they can be follow the condensate quantity, from contoller.

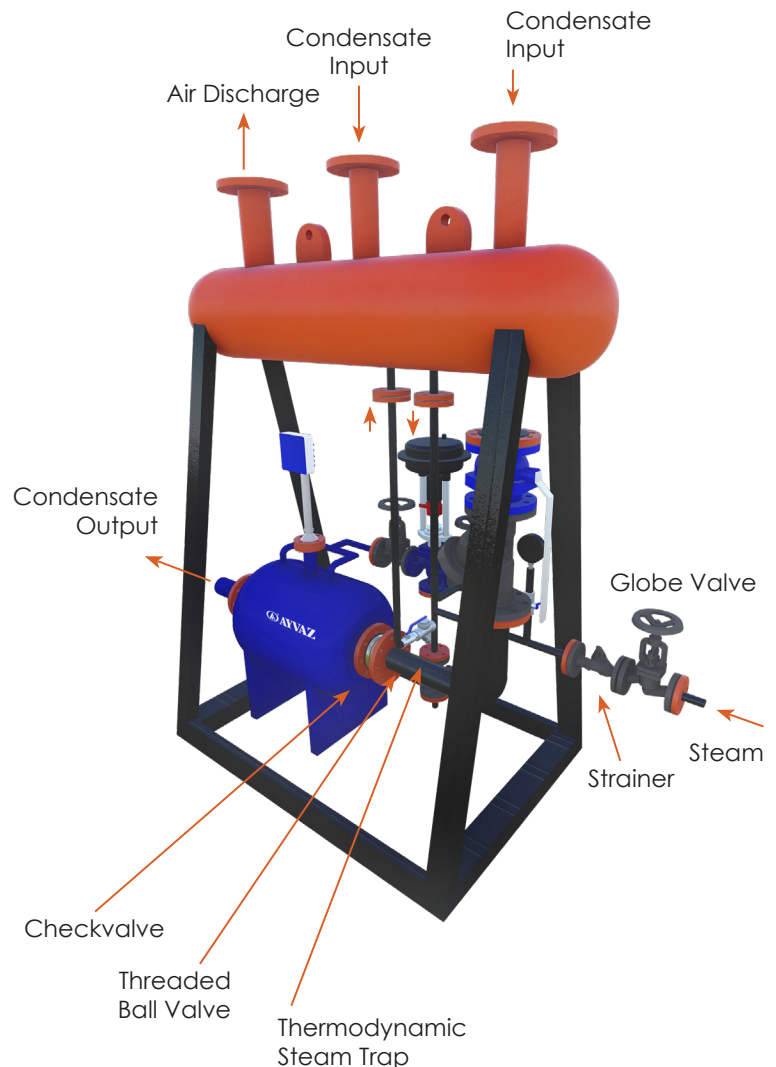

## FLASH STEAM RECOVERY SYSTEMS

The most important components in a cascade system are the Flash Steam Tank Systems which separate the flash vapor from the condensate where the flash and the sweep / blow steam are located.

A common mistake in enterprises is called "separator".

It is important that the condensate is drained effectively and not allowed to accumulate in the separators. They can be emptied with a steam trap, an electrically driven pump / level control device, or a steam-driven pump system with a lower choice of both investment costs and operating costs.

### Why Flash Steam is Important?

It includes too much energy and it can be mount to different installation areas. If Flash Steam drains to the atmosphere there will be waste energy and efficiency lost.

Flash Steam Tanks are used to separate the flash steam from the condensate water.

In order for the flash steam to move towards the top outlet at the correct speed, the diameter of the steam tank must be appropriate. This speed is about 3-5 m/s and the velocity at which water droplets can reach the bottom of the tank. In order to be efficient, the condensate inlet to the tank should be one-third of the tank neck below. The diameter of the flash steam tank should be a diameter that allows the passage of the condensate without coming into turbulence.

If the difference between high and low pressure is small. The amount of steam is less than the amount of condensate.

Flash steam outlet pipe selecting the diameter according to the speed will cause the tank to remain small.

In which case the tank must be selected to be two diameters larger.

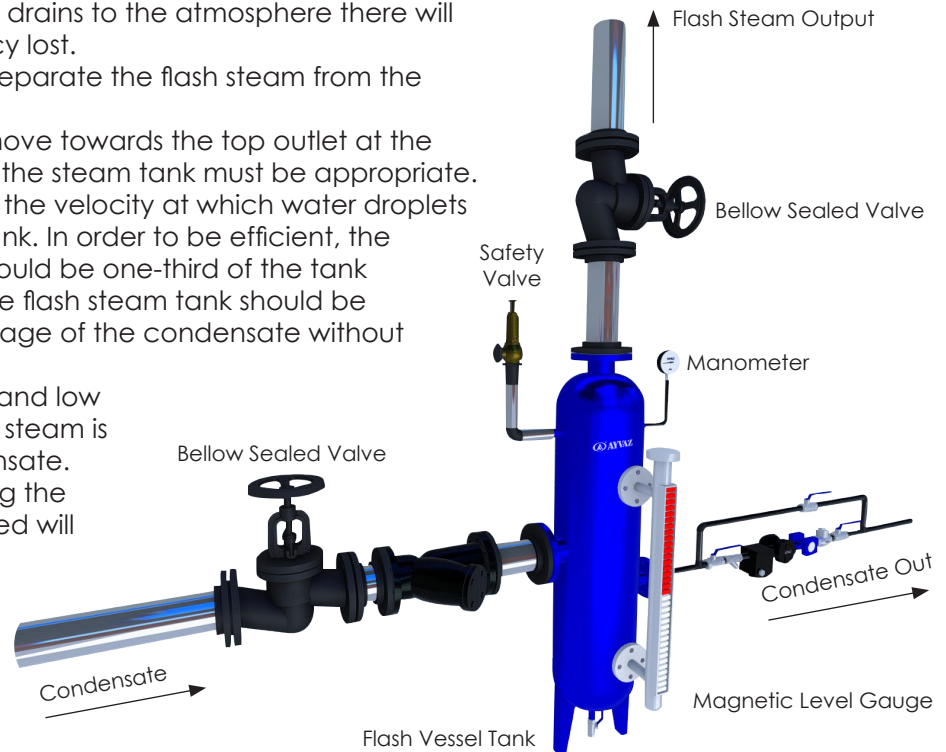

## HEAT EXCHANGERS

---

In today's conditions, where energy is getting more expensive day by day, there is no need to waste energy in industry or individual use. The budgets allocated to energy in industrial establishments have increased by 20% -40% in recent years and they are at the top of the expenses section. Taking all these points into account, the recovery of energy has become very important. Ayvaz plate heat exchangers prevent the waste of your thermal energy with wide variety of plate and gaskets suitable for each system.

Industrial facilities have many wasted heat sources such as rotten steam and hot water returning from fabric washing. At the same time, there are applications that require heat, such as domestic hot water production and office heating. With the Ayvaz plate heat exchanger you will use to transfer heat from existing heat sources to the part that needs heat, you do not waste your heat and you need to save extra heat for the heat requirement. Nowadays, the most important factor that will relax businesses is to reduce costs. Energy expenses, one of the biggest factor in expenses, are now worth the gold for everyone and cannot be ignored. A heat exchanger to be used for heat recovery with a rough calculation now pays off in 3-6 months and starts to add value to the operation in a short time.





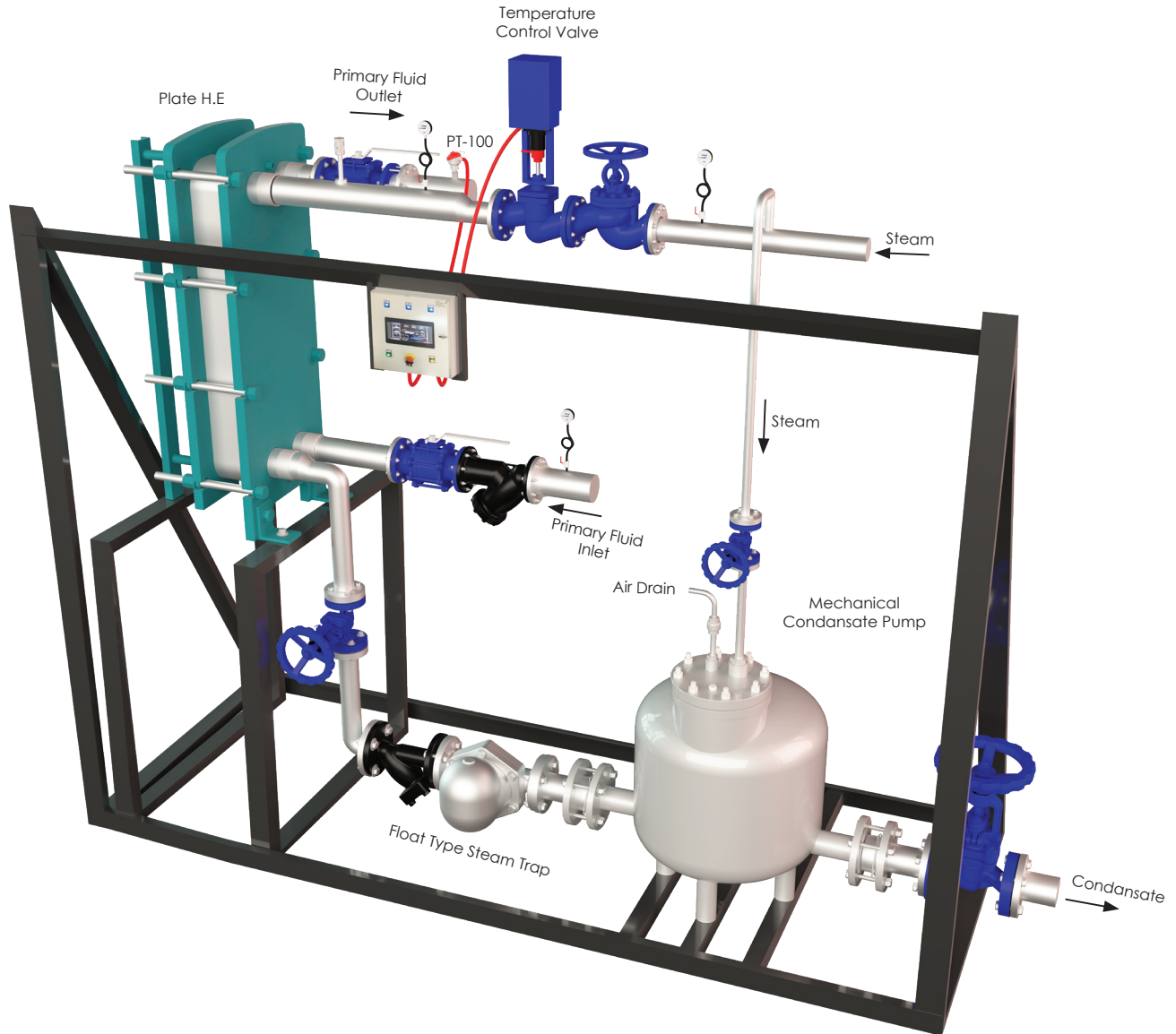

## PRESSURE REDUCING STATION

It requires a primary steam pressure of up to 7 bar for older-style machines in laundry lines and up to 16 bar for new high-speed machines.

Regardless of the type of steam or condensate management system, the primary vapor pressure on the line should be accurate and balanced.

Folding machine's rollers, small pre-heaters, press irons and cylinder irons usually operate at the highest temperature.

Required high pressure steam within  $4 \pm 0.3$  bar ( $\pm 2^\circ\text{C}$ ).

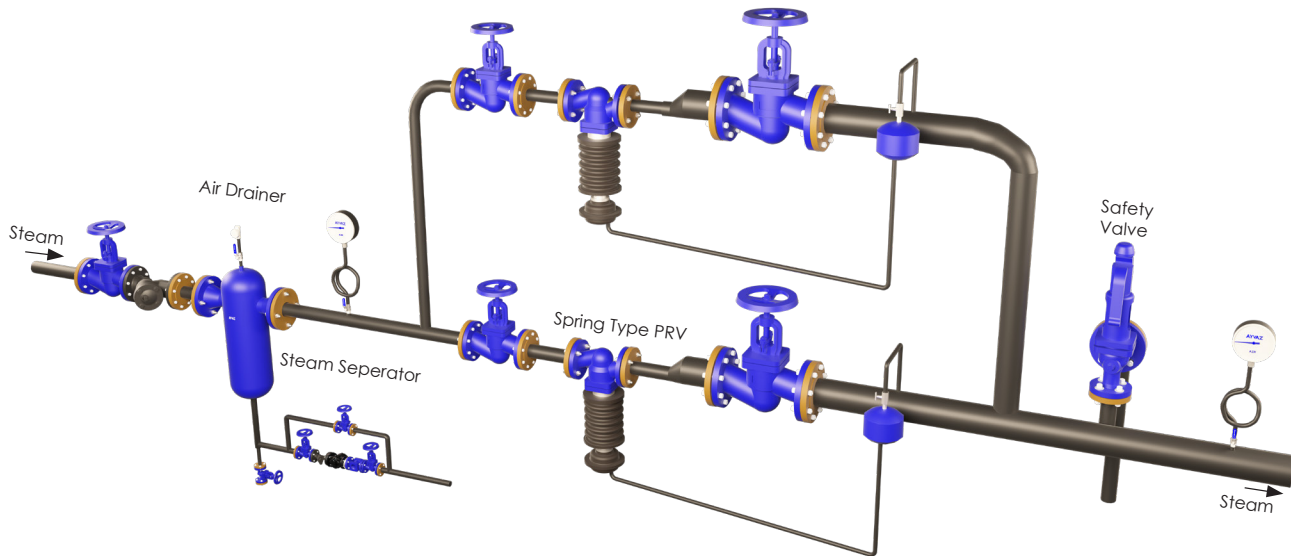

The choice of the main pressure reducing valve must depend on the needs of the system. In a folding machine where the same pressure is always required in high temperature cylinders with a very stable demand throughout the process, a direct effective pressure reducing valve of the correct size can be safely used.

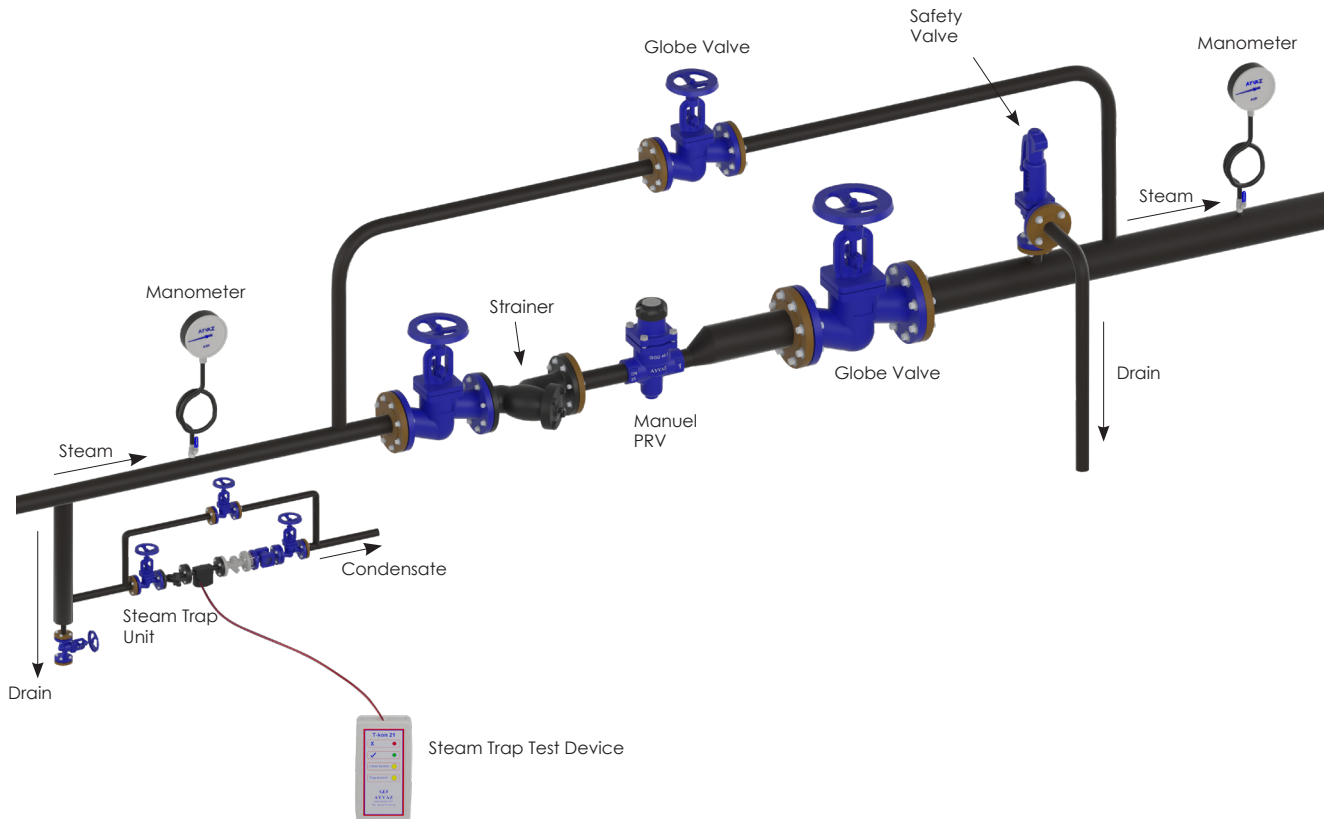

## STEAM LINE APPLICATIONS

### MAIN STEAM LINE APPLICATION

Condensate discharge unit should be placed in main steam lines in every 50 meters if the line is indoor and insulated or in every 30 meters if the line is outdoor and insulated. If any equipment like pressure reducer, pressure holder or proportional valve is installed in the line, a condensate discharge unit must be placed before these equipment.

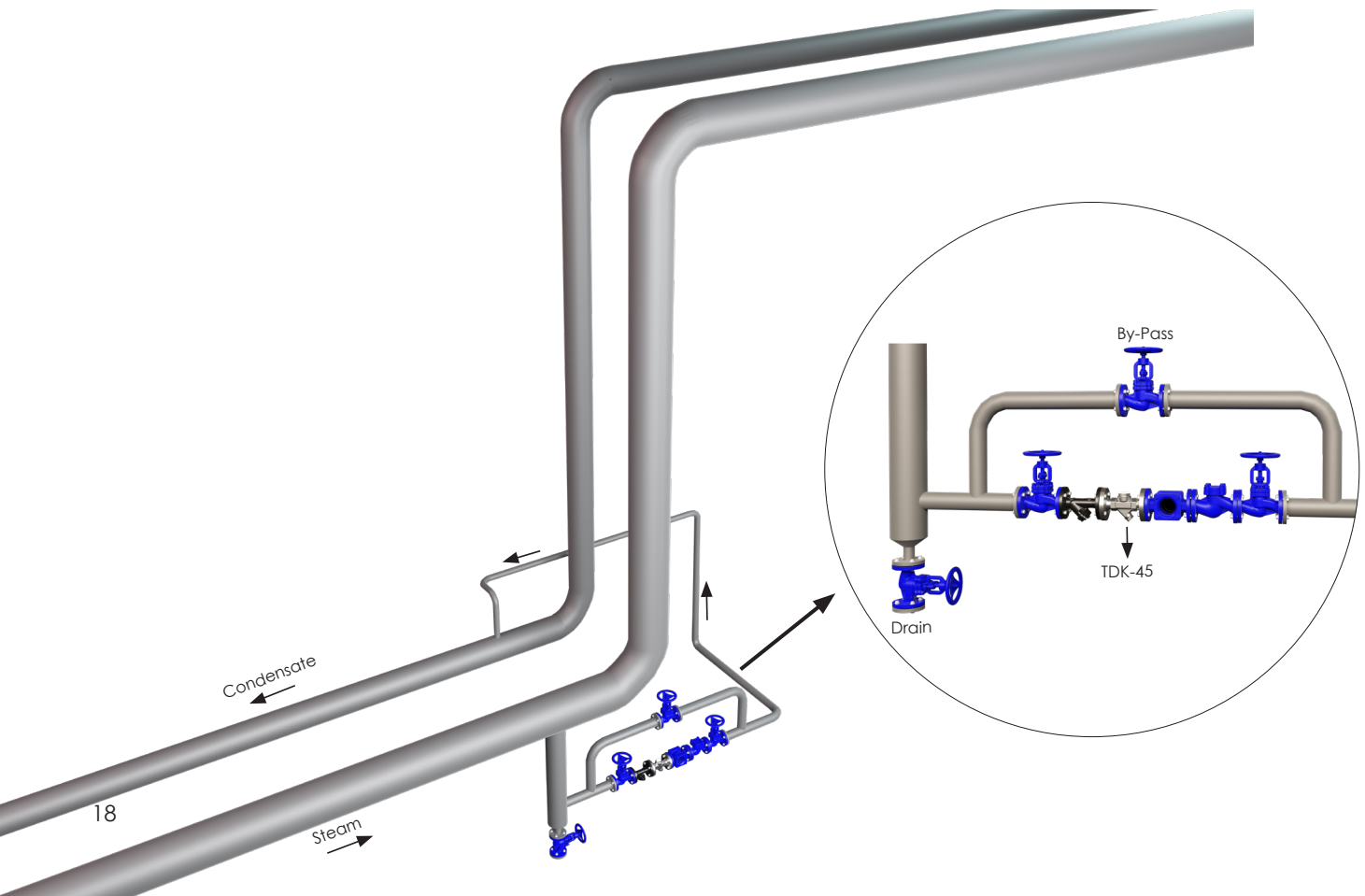

## LINE END APPLICATION

If the steam systems are closed by the process, the steam will turn to condensation until it is turned on again. The volume difference will be filled with air. When the system is switched on again, the air must be evacuated to allow the steam to easily fill the line. This is only possible with “End of Line Application”.

The occurred air and condensate around connection areas in the pipelines are dragged to the end of the line. If that air and condensate are not discharged, they may block the steam flow. In such cases, formed air and condensate are discharged with a line end application shown below. The steam trap kind must be thermodynamic.

Main Steam Line (D)	Pocket Dia (d1)
15-100mm	d1= D
125-200 mm	d1= 100 mm
250 mm +	d1= D/2

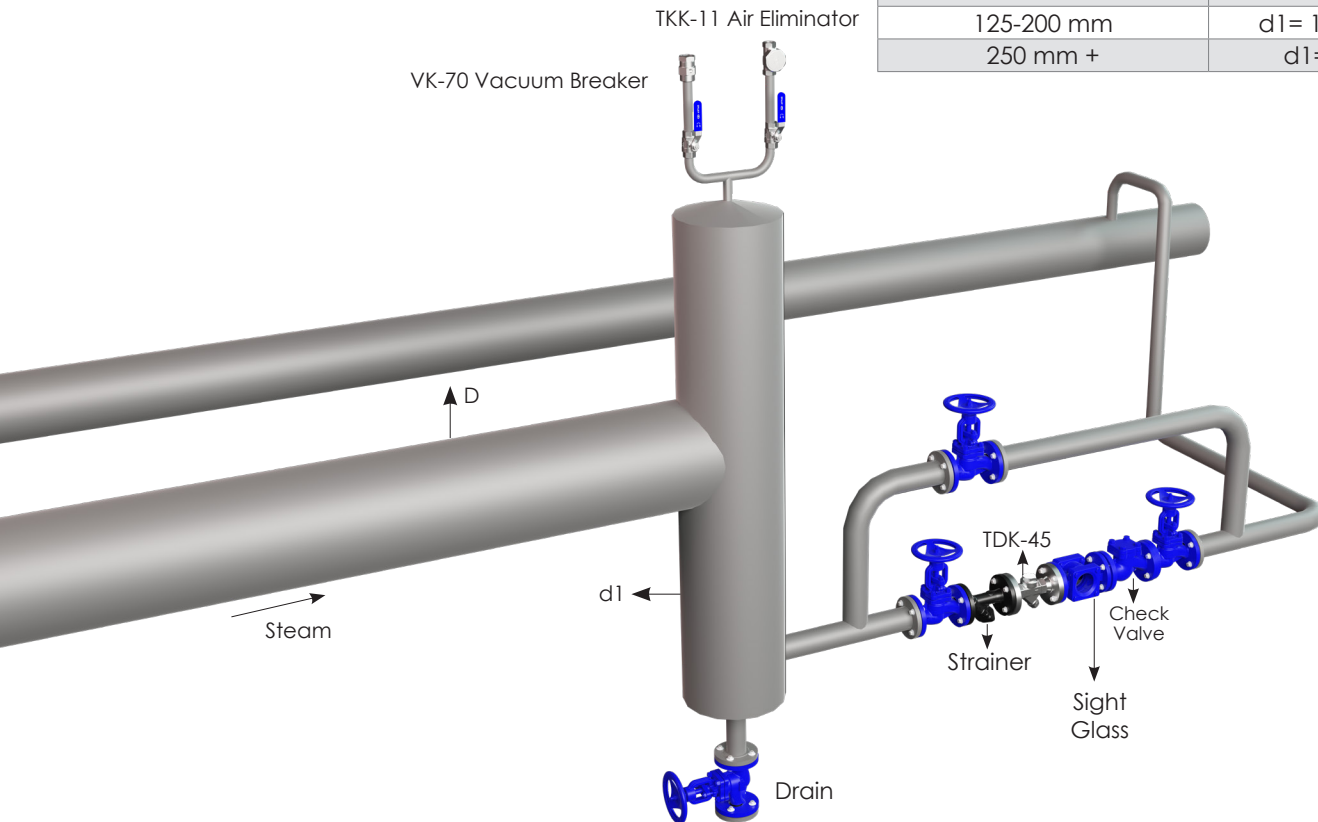



# PROPORTIONAL FEED WATER SYSTEMS

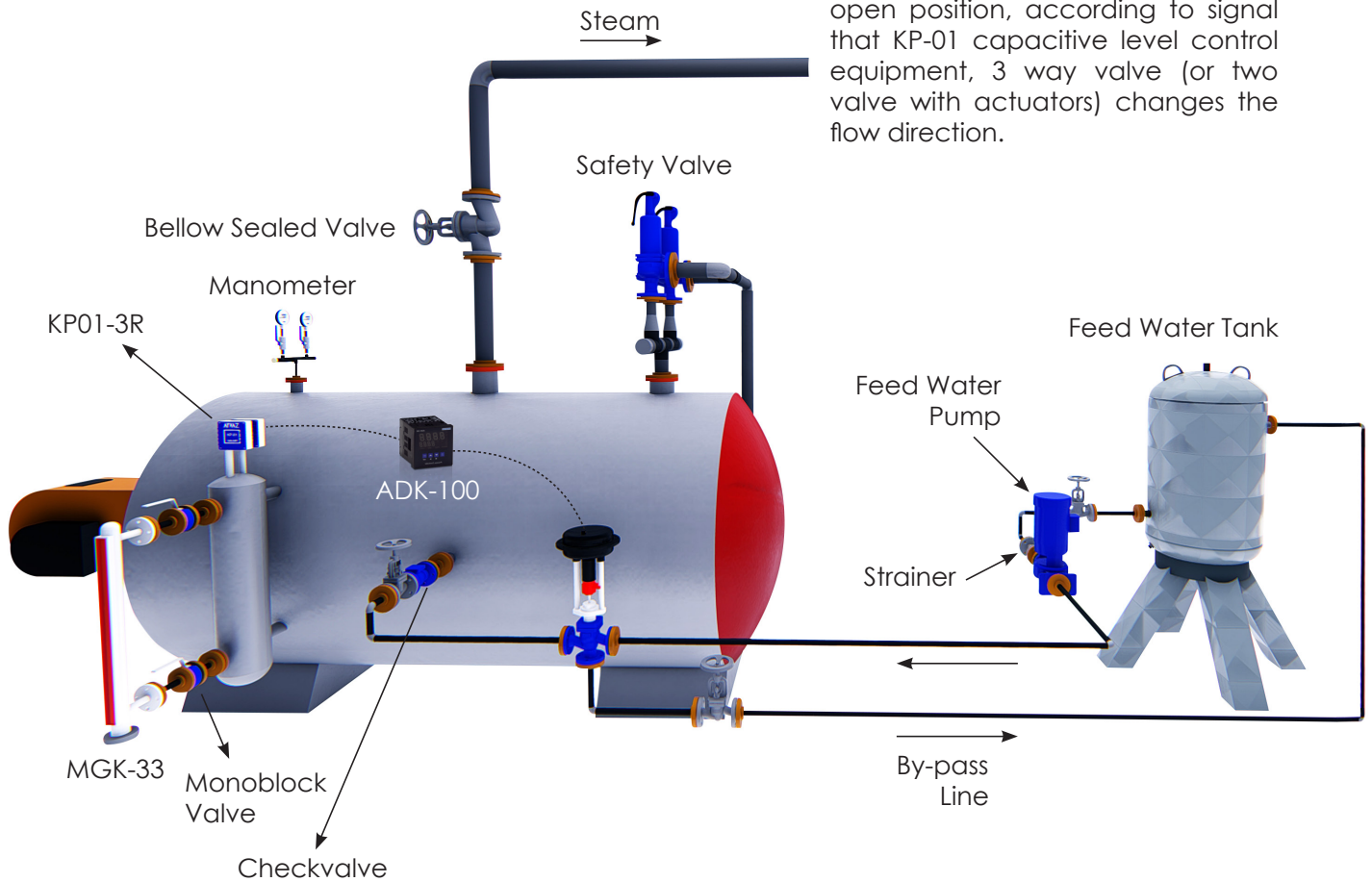

Feed water pump is always in open position, according to signal that KP-01 capacitive level control equipment, 3 way valve (or two valve with actuators) changes the flow direction.

## ON-OFF FEED WATER SYSTEMS

Feed water pump is opening and closing continuously, according to signal that ELK-4 probe level control equipment, control valve changes the flow direction.

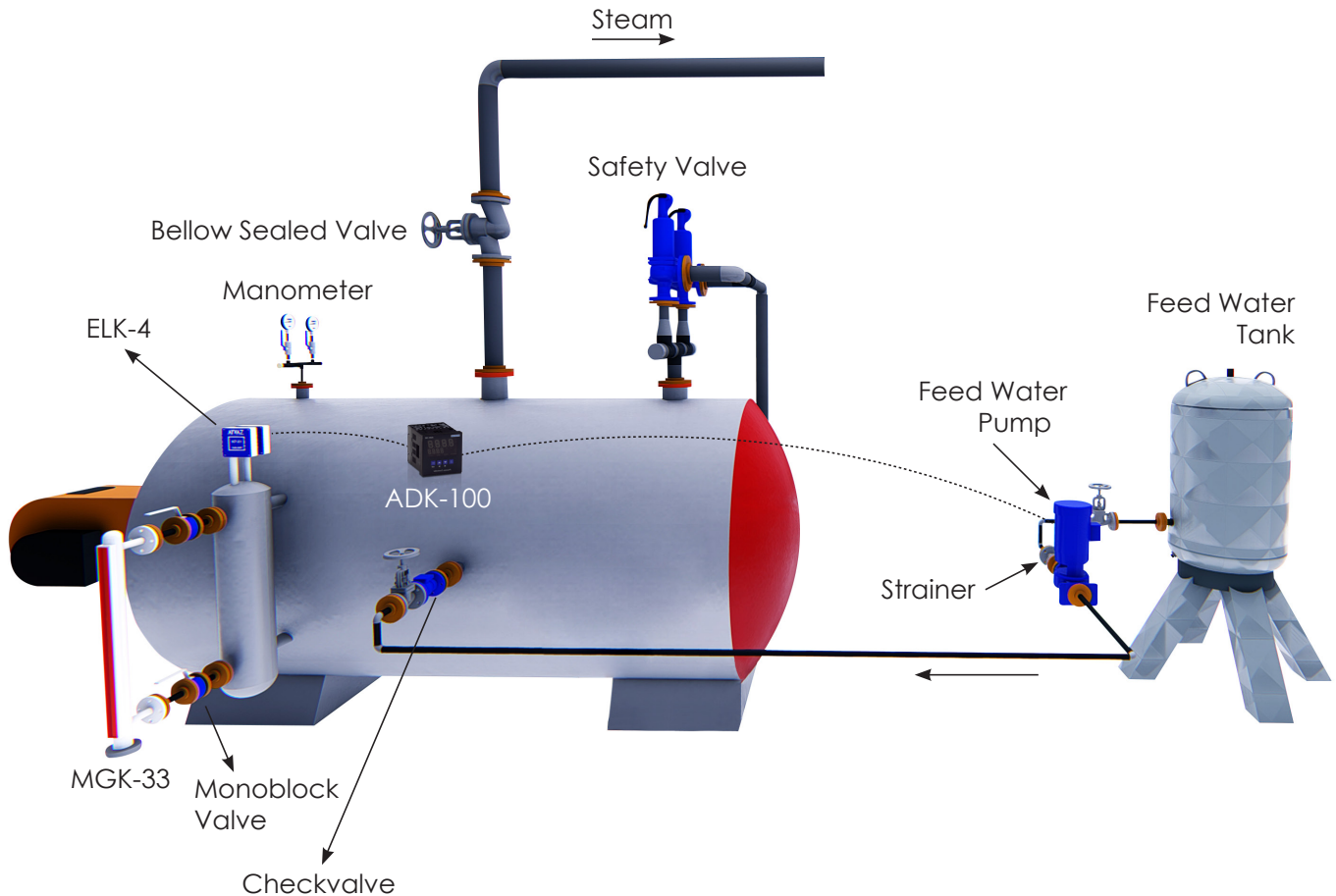

# APPLICATION EXAMPLE

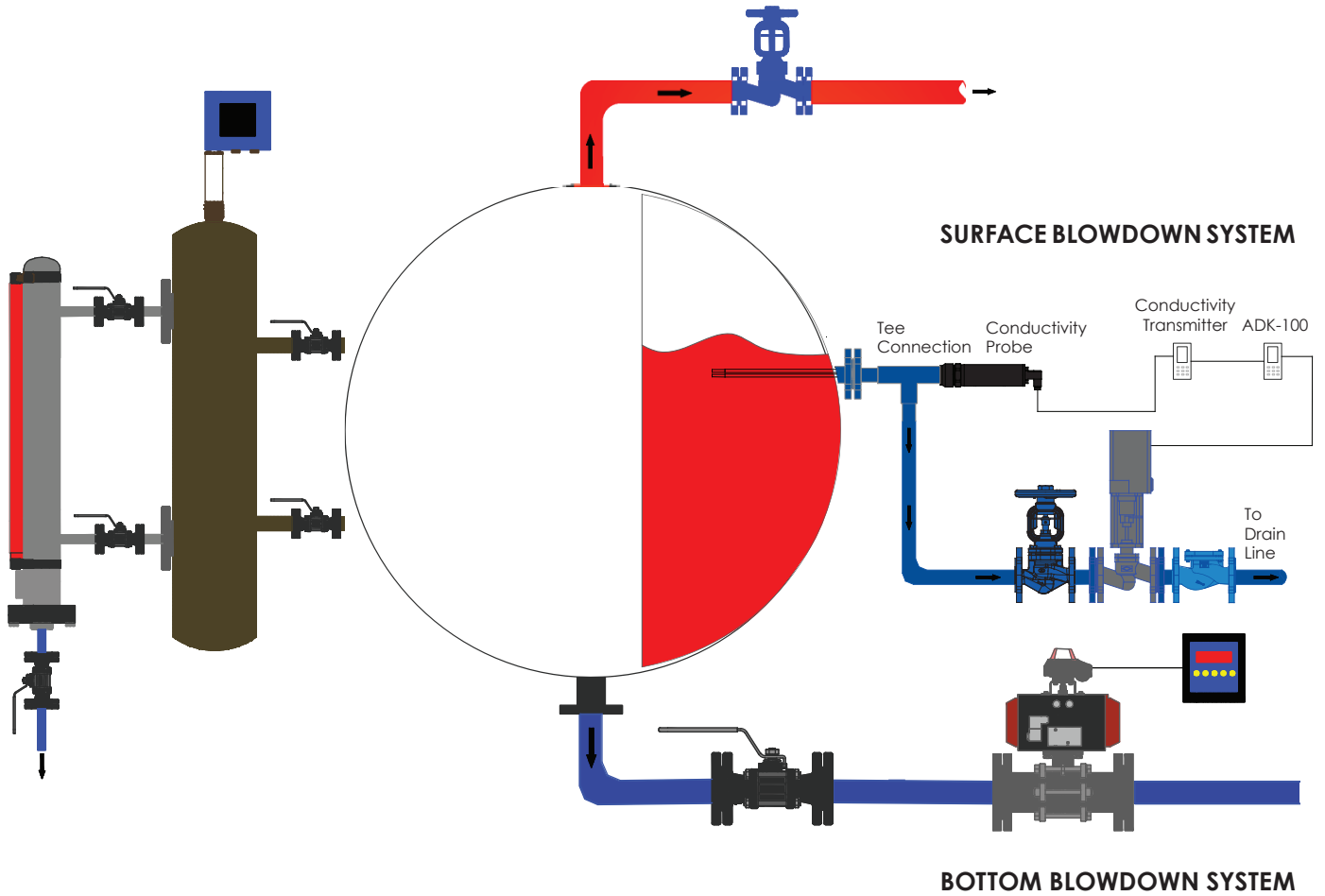

## BLOWDOWN SYSTEMS

---

Surface blowdown and bottom blowdowns are required to ensure a continued safe transmission of the boiler. Sludge deposits are formed in the boiler and must be cleaned at regular intervals.

Sediments must be evacuated periodically to prevent the formation of the sludge layer. Bottom blowdown valves are used for this purpose. The bottom blowdown valve is opened and the pressurized boiler water is discharged from the lower zone of the boiler.

When the valve is opened, the sludge in the lower area of the boiler is effectively discharged by the high water velocity due to the pressure difference. Depending on the type of water preparation system and the dosing system, the steam boiler reaches salt and other foreign substances.

As a result of evaporation, the salinity in the boiler water increases. Salt concentration higher than the limit value causes the boiler stone, boiler corrosion and foam formation.

The foam can also reach the steam installation. Thus, the steam quality decreases and the accumulation of water forces the armatures.

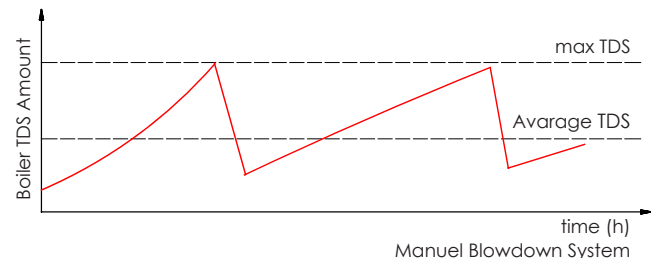
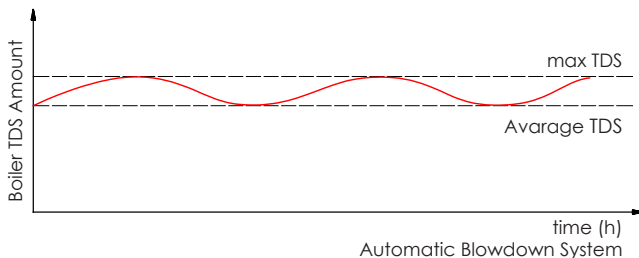

## CONDENSATION RECOVERY LINE

After process, saturated steam will transfer the energy and condensation will collect with steam traps to the condensate tanks. Condensate will mix with water supply in feed water tank by pumps, like the diagram below.

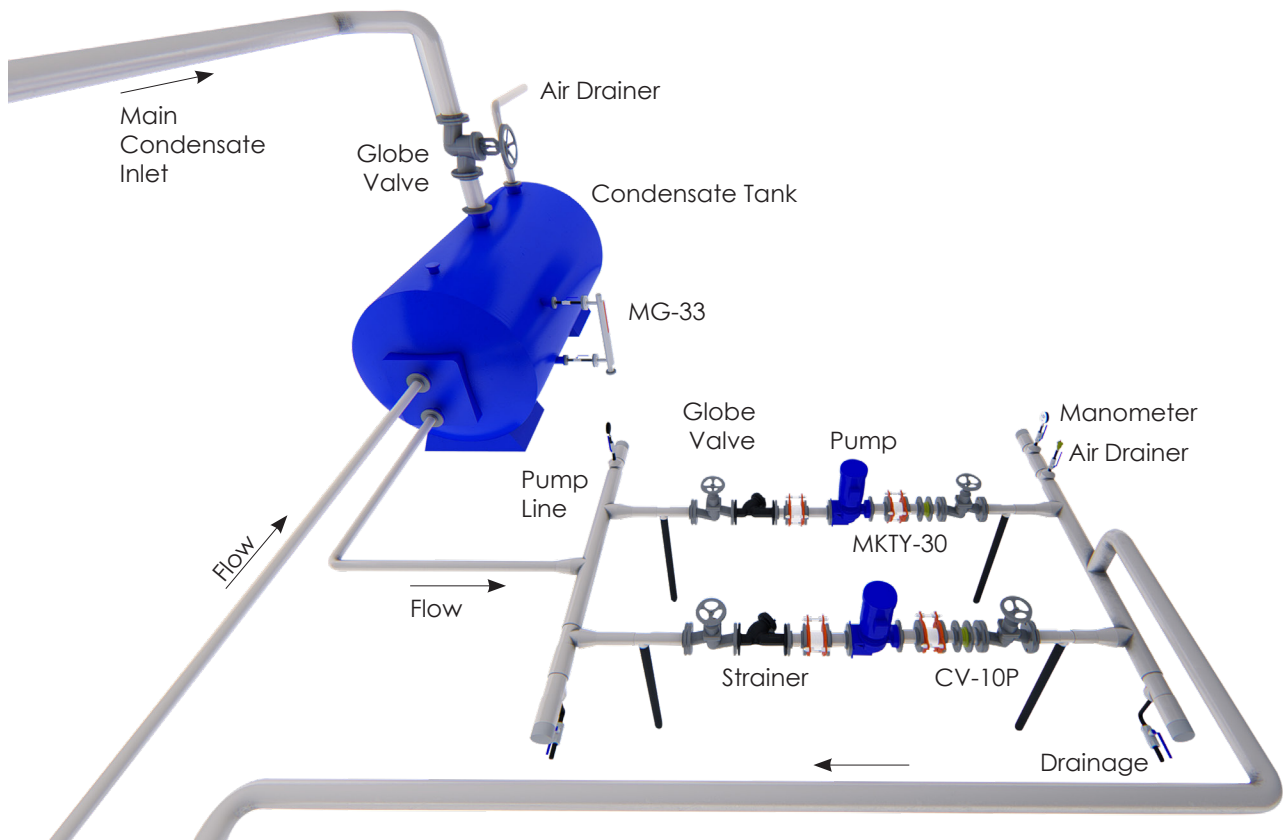



# DEAERATORS

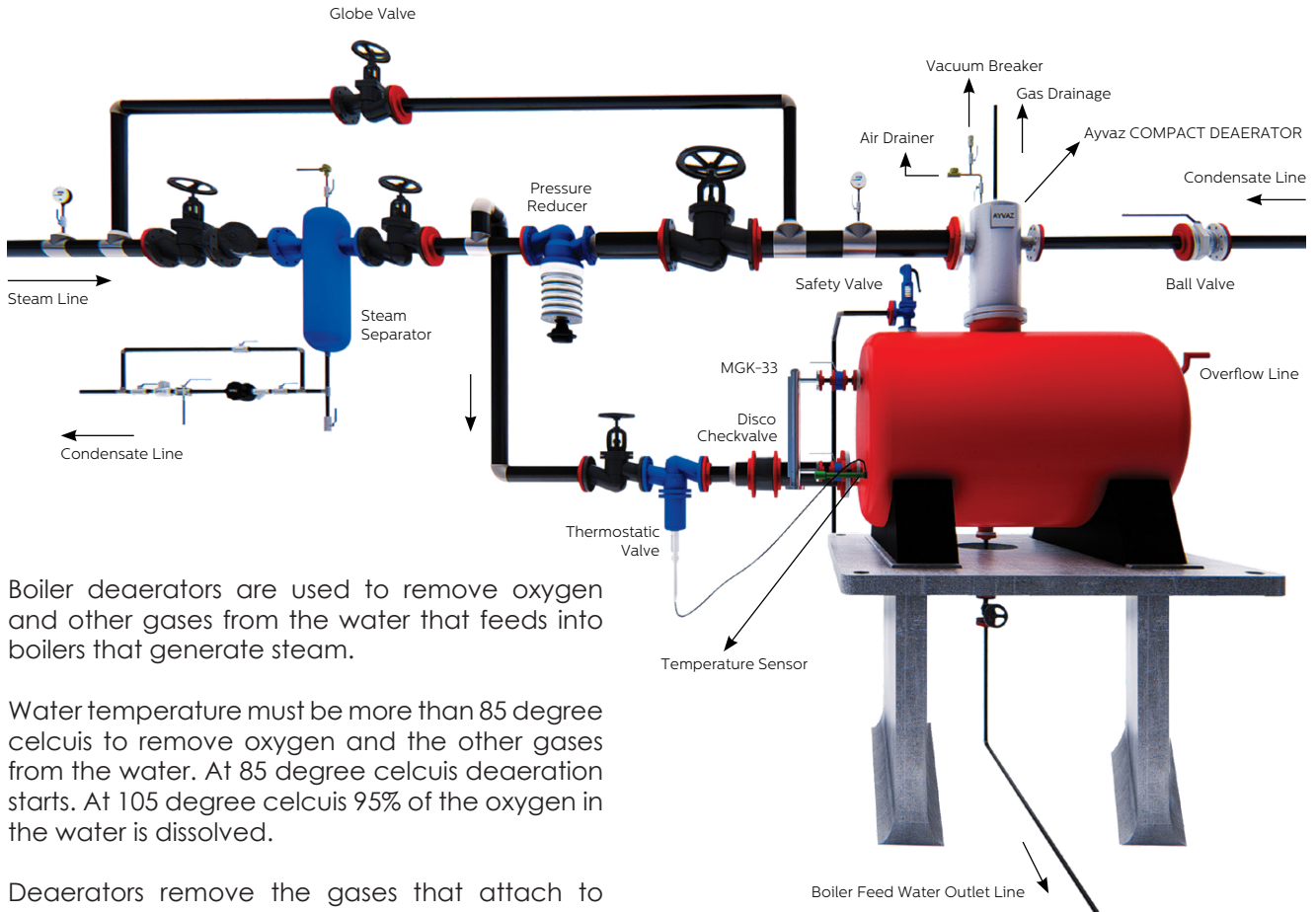

Boiler deaerators are used to remove oxygen and other gases from the water that feeds into boilers that generate steam.

Water temperature must be more than 85 degree celcius to remove oxygen and the other gases from the water. At 85 degree celcius deaeration starts. At 105 degree celcius 95% of the oxygen in the water is dissolved.

Deaerators remove the gases that attach to the metallic components of the steam system and cause corrosion by forming oxides, or rust. Oxygen and carbon dioxide are responsible for corrosion(pitting). There are two types of boiler deaerators: Tank model or compact deaerators.

## BOILER ROOM

The system that distributes steam is called collector. Steam condensates in the collectors. The condensate is usually charged by thermodynamic steam traps from the collectors.

Steam collectors are the first stop in steam distribution. Saturated steam comes directly from boiler. MK-16 bellow seal valves are best option instead of globe valves at this installation.

Collector sizes can be calculated with  $D = \sqrt{(d_1^2 + d_2^2 + d_3^2 \dots d_n^2)}$  formula. Steam trap's pocket size can be selected according to the selection table below;

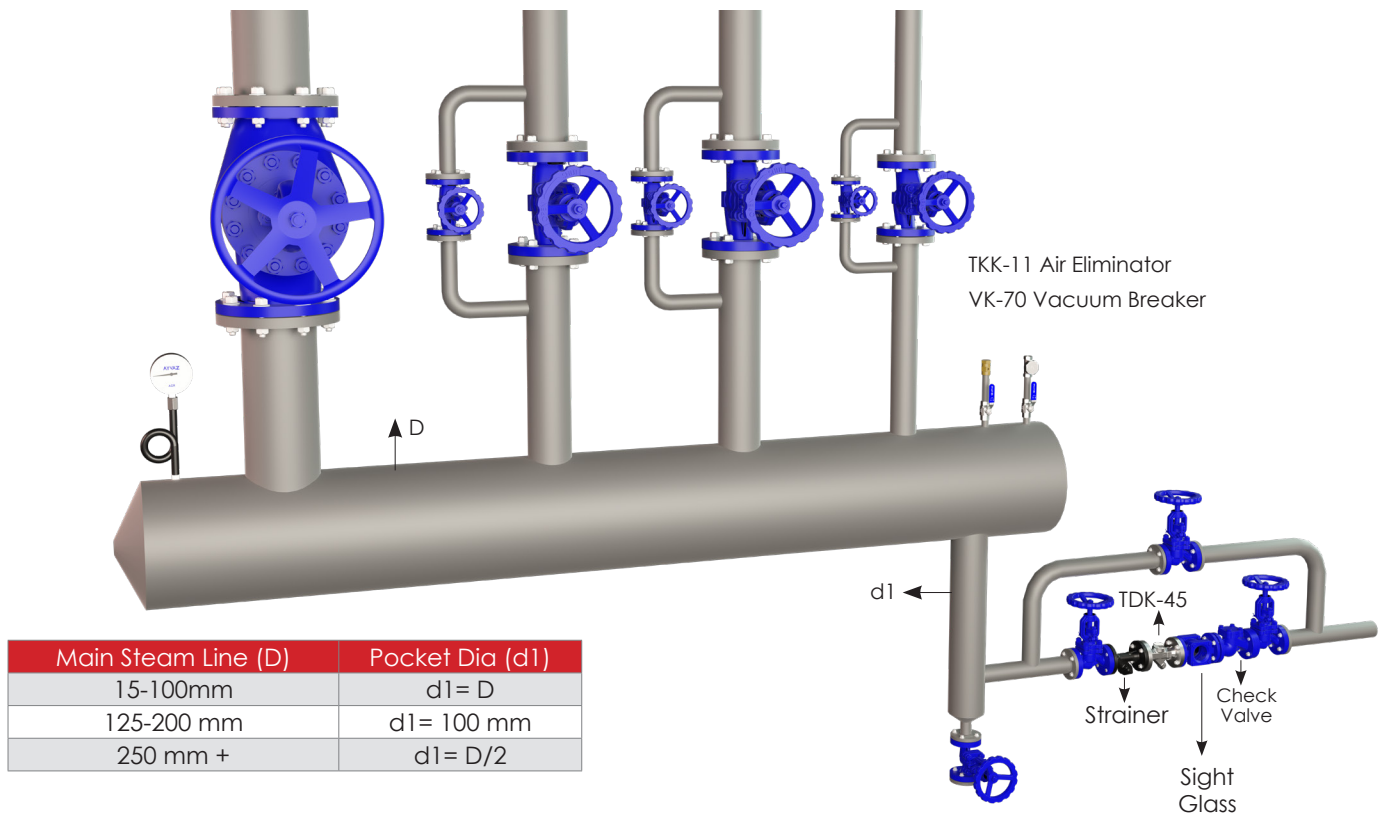

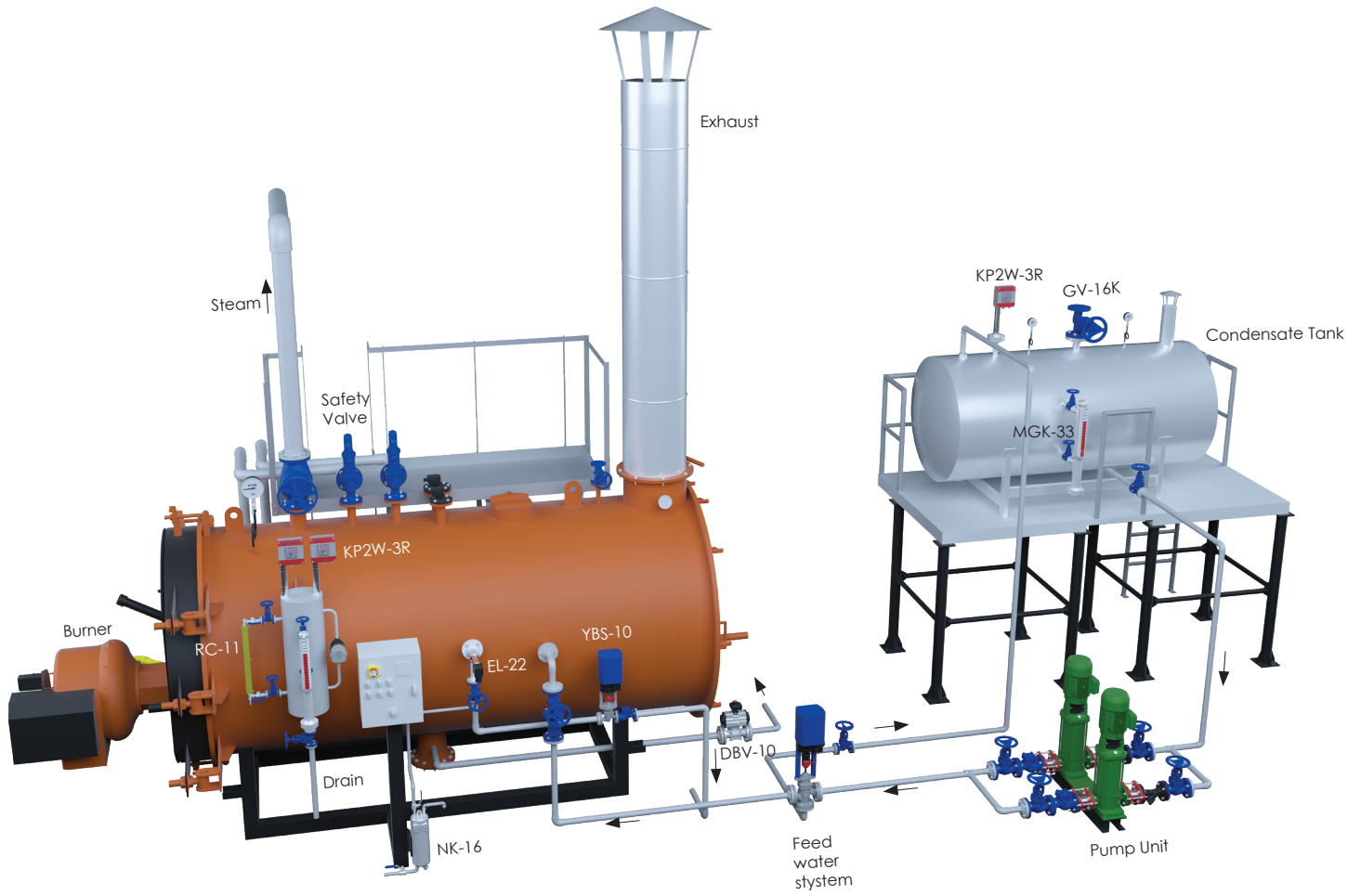





HEAD OFFICE - MAIN FACTORY  
Atatürk Sanayi Bölgesi Hadımköy Mahallesi  
Mustafa İnan Caddesi No: 44 Arnavutköy - İSTANBUL  
Tel: +90 212 771 01 45 (pbx) | Fax: +90 212 771 47 27  
info@ayvaz.com | www.ayvaz.com



**Cona**  
Caserta / Italy  
Tel : +39 0823 187 3988  
rmolaro@ayvaz.com



**Ayvaz Ukraine**  
Kiev / Ukraine  
Tel : +380 44 390 57 57  
info@ayvaz.com.ua



**Tricorr**  
Warsaw / Poland  
Tel : +48-32-783-295-1  
tricorr@tricorr.eu



**Ayvaz Germany**  
Viernheim / Germany  
Tel : +49 62046014399  
germany@ayvaz.com



**Ayvaz Serbia**  
Belgrade / Serbia  
Tel : +381 61 658 70 52  
yakbiyik@ayvaz.com



**Ayvaz Azerbaijan**  
Baku / Azerbaijan  
Tel : +99(455)579-84-32  
ahayatov@ayvaz.com



**Ayvaz Kazakhstan LLP**  
Almaty / Kazakhstan  
Tel : +7 (727) 327 97 57  
www.ayvaz.kz



**Ayvaz N**  
Ispirih / Bulgaria  
Tel : +359 8431 27 32  
office@ayvaz-n.eu



**Ayvaz Vietnam**  
HCMC / Vietnam  
Tel : +84 89 8508345  
ggursoy@ayvaz.com



**Ayvaz China**  
Ningbo / China  
Tel : +86 152 5830 7361  
msahin@ayvaz.com



**Ayvaz Egypt**  
Cairo / Egypt  
Tel : +20 122 819 78 29  
andrew.eid@ayvaz.com



**Ayvaz Gulf**  
Dubai / U.A.E.  
Tel : +971 563550822  
+971 501306871  
mideast@ayvaz.com



**Ayvaz Americas**  
Rhode Island  
Tel : +1 401 737 8380  
americas@ayvaz.com