



A MEMBER OF  
EURO-QUALIFLEX



## MIG-FLEX EXTENSIBLE, FLEXIBLE METAL HOSES

MIG-GAS

MIG-SU



Scan this QR Code



## MIG-GAS (NATURAL GAS CONNECTIONS)



### Application Areas

- Natural gas applications
- Kitchen appliances
- Combi boilers and water heaters
- Cookers and grills



### Design

With their closed pitch corrugated structure, Mig-gas hoses provide a highly flexible and extensible connection for all kitchen appliances. It can be manufactured with or without polyolefin based cover. Mig-flex hoses are exposed to special heat treatment.

Heat Treatment eliminates the stresses caused by the tubing, mechanic forming and fitting welding processes and increases the flexibility as well as the corrosion resistance of hoses while reducing the spring rate accordingly. Heat treatment helps hose to save the form and the shape given.

### Advantages of Ayvaz's MIG-GAS Natural Gas Connection Hoses:

#### Connection:

- Extensible structure provides the best connection features for non-classified distances.
- Offers great connection features for all indoor natural gas applications as a household gas hose to cookers, gas stoves and fireplaces, gas-operated grills, barbecues, combi boilers and heaters.
- Can be installed in tightest bending radius with no reduction in cross sectional area.

#### Economic Installation:

- Reduces the cost and time for installation with its highly flexible and extensible structure.
- Provides the best connection features possible, at various installation distances and can be manufactured in all lengths from 90mm up to 2000mm.

### Safety:

- Mig-gas hoses are produced with the highest degree of safety and guaranty the highest level of health and safety for the users. (acc. UNI 11353 and UNE 60713/1)
- Non-flammable, polyolefin shrink protects the hose against the corrosive effects of the chemicals such as cleaning materials, fire and mechanical damages.

### Service Life:

- Production process (heat treatment) homogenizes the hose material and provides a relieved structure from occurred stresses that increases the service life of the hose accordingly.



## MIG-GAS (NATURAL GAS CONNECTIONS)

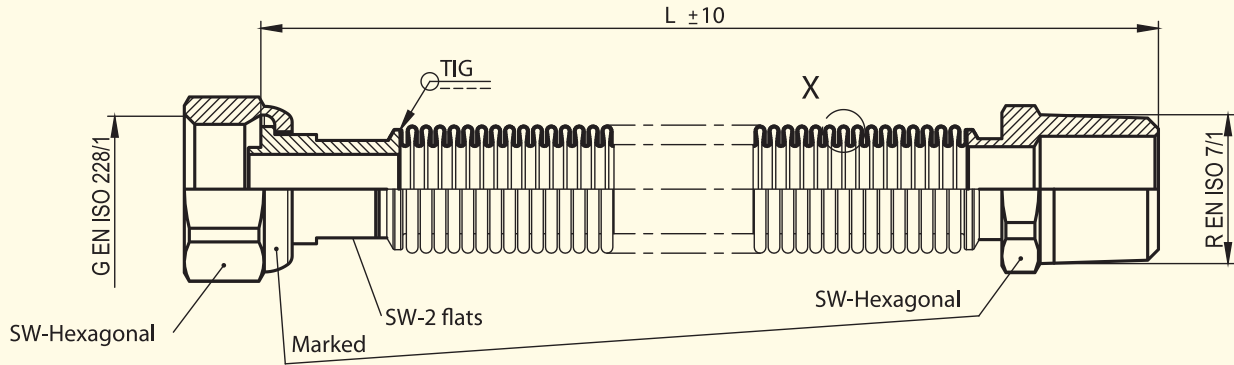

### PRODUCT FEATURES

Hose Type	: Closed pitch corrugated extensible metal hose
Hose Material	: Stainless Steel AISI 316L
Fittings Types	: Female-Male/Female-Female
Fittings Materials	: Nut in Stainless Steel AISI 304/303 EN ISO 228/1 Nipple in Stainless Steel AISI 304/303 EN ISO 7/1
Cover	: Polyolefin Cover in Yellow or coverless
Gasket	: NBR / Aluminium

NOMINAL DIMENSIONS		
DN	Connection	Length (mm)
12	1/2"x1/2"	90x140
	1/2"x3/4"	130x220
20	3/4"x3/4"	220x420
		300x600
25	1"x1"	500x1000
		750x1500
		1000x2000

Special lengths for specific purposes may be available on request.

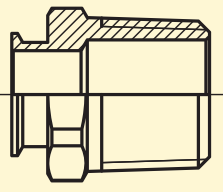
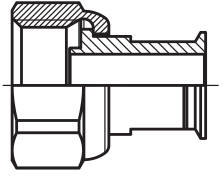
CONNECTIONS				
No	Type of Connection	Material	DN	inch
1	 <p>Male Connection EN ISO 7/1 thread</p>	Stainless Steel AISI 304 (1.4301)	12 20 25	1/2" 3/4" 1"
2	 <p>Swivel Female Connection EN ISO 228/1 thread</p>	Inner Part and Nut Stainless Steel AISI 304 (1.4301)	12 20 25	1/2" 3/4" 1"

## MIG-SU (WATER APPLICATIONS)



### Application Areas

- Sanitary
- Radiator connections
- Combi boilers, water heater connections
- Washing machine connections
- Tank and storage connections
- Expansion tank connections
- Decorative piping system

### Design

Mig-Su water connection hose is a highly flexible structured, time and cost saving hose assembly which is highly resistant against pressure and temperature. Ayvaz's Mig-Su hose prevents the problems caused by rigid connections.

Because of the hose's flexible design, corrugations are able to make expansion and compress movements and this provides a non-calcified structure.

Heat Treatment eliminates the stresses caused by the tubing, mechanic forming and fitting welding processes and increases the flexibility as well as the corrosion resistance of hoses while reducing the spring rate accordingly. Heat treatment helps hose to save the form and the shape given.

### Advantages of Ayvaz's MIG-Su Water Connection Hoses:

#### Connection:

- Extensible structure provides the best connection features for non-classified distances.
- Offers great connection features for all indoor water connections as a flexible water connection hose to sanitary applications, tank and storage connections, combi boilers and heaters.
- Can be installed in tightest bending radius with no reduction in cross sectional area.

#### Economic Installation:

- Reduces the cost and time for installation with its highly flexible and firm structure.
- Provides the best connection features possible at long connections and can be manufactured in all lengths from 90mm up to 2000mm.

### Safety:

- Mig-su hoses are produced with the highest degree of safety and guaranty the highest level of health and safety for the users. (acc. UNI 7129)
- Non-flammable, polyolefin shrink protects the hose against the corrosive effects of the chemicals such as cleaning materials, fire and mechanical damages.

### Service Life:

- Production process (heat treatment) homogenizes the hose material and provides a relieved structure from occurred stresses that increases the service life of the hose accordingly.

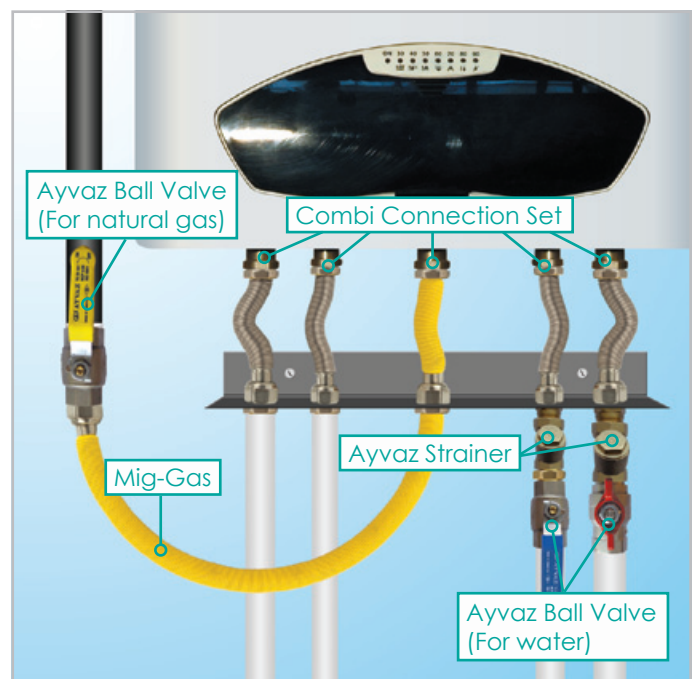

# MIG-SU (WATER APPLICATIONS)

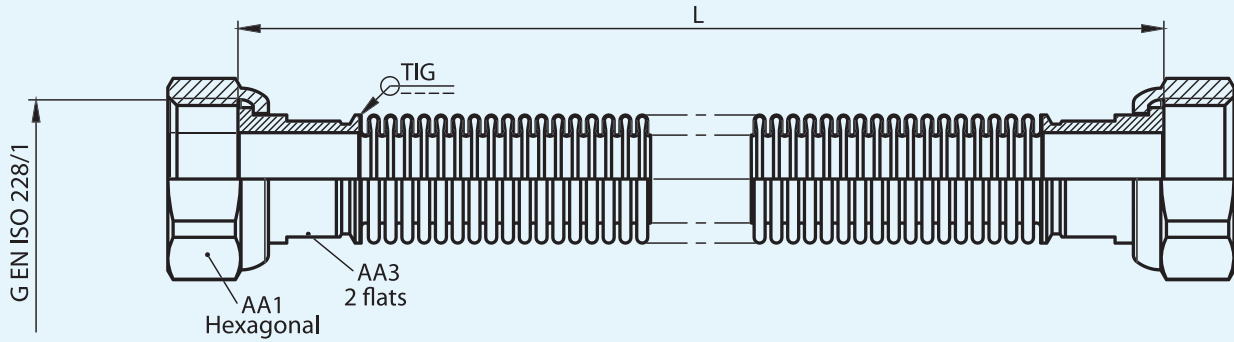

## PRODUCT FEATURES

- Hose Type : Closed pitch corrugated extensible metal hose
- Hose Material : Stainless Steel AISI 316L
- Fittings Types : Female-Female, Female-Male
- Fittings Materials : Nipple in stainless steel EN ISO 7/1  
Nut in Brass EN ISO 228/1  
Internal parts in stainless steel
- Cover : Polyolefin Cover in White or Coverless
- Norm : UNI 7129

NOMINAL DIMENSIONS		
DN	Connection	Length (mm)
12	1/2"x1/2"	90x140
	1/2"x3/4"	130x220
20	3/4"x3/4"	220x420
		300x600
25	1"x1"	500x1000
		750x1500
		1000x2000

Special lengths for specific purposes may be available on request.

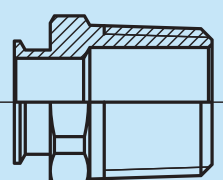
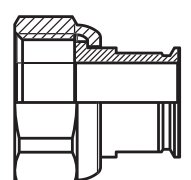
CONNECTIONS				
No	Type of Connection	Material	DN	inch
1	 Male Connection EN ISO 7/1 thread	Stainless Steel AISI 304 (1.4301)	12 20 25	1/2" 3/4" 1"
2	 Swivel Female Connection EN ISO 228/1 thread	Inner Part Stainless Steel AISI 304 (1.4301) Nut Nickel Coated Brass	12 20 25	1/2" 3/4" 1"

## COMBI CONNECTION SET



### Application Areas

- Complete hose set includes Mig-Gas and Mig-Su hoses
- For combi boilers, gas and water connections

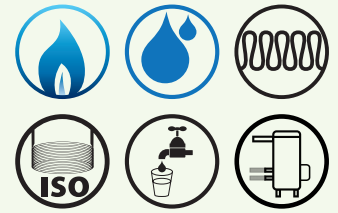

HOSE DIMENSIONS	DN	QTY	CONNECTION	TYPE	LENGTH (mm)
	12	2	1/2"x1/2" MF	Mig-Su	220x420
	20	2	3/4"x3/4" MF	Mig-Su	
	20	1	3/4"x3/4" MF	Mig-Gas	

### INSTALLATION

- The hose line should be installed without exposed to twisting.
- No torsion stress must occur neither during the assembly, nor the operating. Otherwise, the service life of the hose reduces.
- Both ends of the hose and the movement must be on the same plate.
- Only one end of the hose must be tightened first to be assured that no twisting on the hose assembly occurs. Afterwards, the hose must complete its movement for couple time while it is in neutral position under no torsions.
- Finally the other end of the hose must be connected.

## Some Examples For Proper Hose Assemblies

The hose must be installed in an arc of 180°. The nominal hose length and installation distance are calculated in a relation with bending radius.

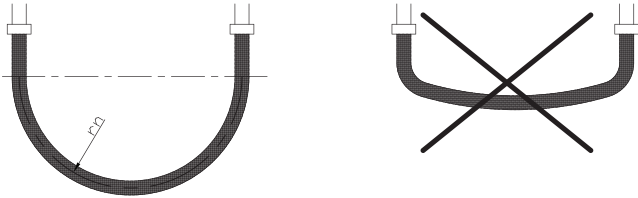

Non-permissible deflections caused by the rigid pipepieces behind the hose connections must be avoided. Minimum bending radius should be detected.

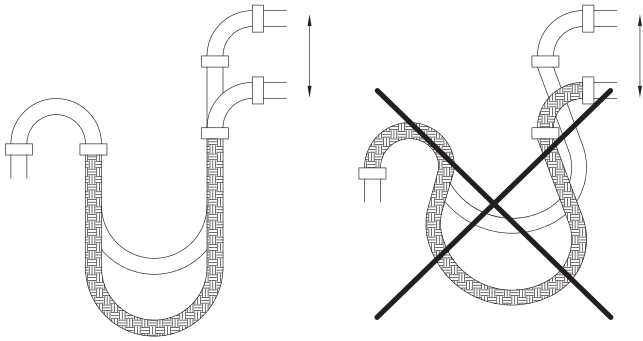

The direction of the hose movement and hose axis should be on the same plate. This prevents the dangerous torsion stress.

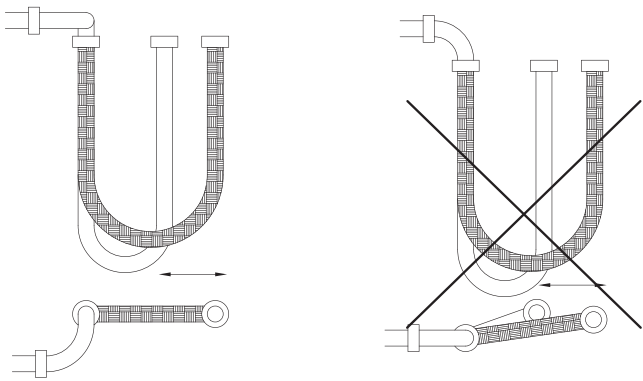

The hose line should be protected from the deflections and sharp strains caused by the support points behind the connection fittings of the both ends of the hose. In such cases, using a bobbin or guiding chain may be useful.

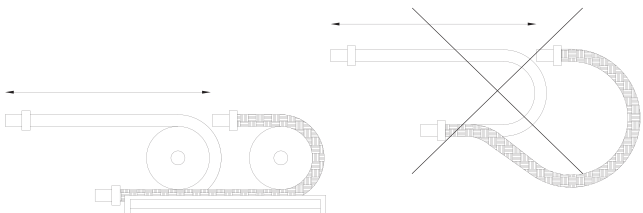

Connection arcs or elbows made by rigid pipe pieces may prevent the bending stress and torsions.

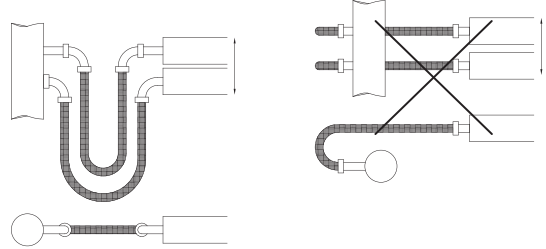

Connection arcs or elbows made by rigid pipe pieces may prevent the sinuous bending stress and extreme torsions.

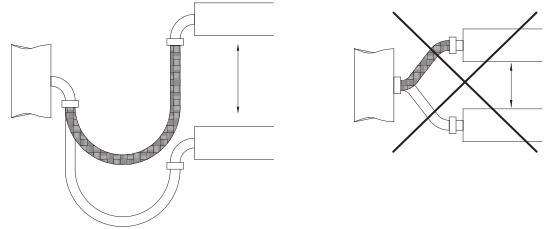

Hose bend and the direction of the movement must be on the plate, this way the torsion can be prevented to reach dangerous levels.

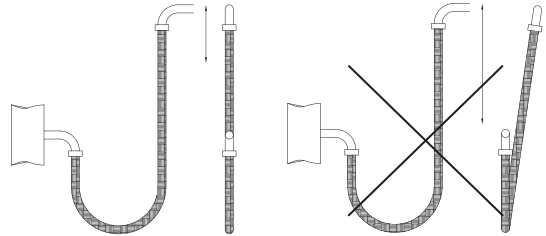

Hose must be hanging freely and it should be installed as it does not contact anywhere even at the maximum expansion situation.

