



TECHNICAL DATA

ESFR PENDENT SPRINKLER VK500 (K14.0)

The Viking Corporation, 210 N Industrial Park Drive, Hastings MI 49058

Telephone: 269-945-9501 Technical Services: 877-384-5464 Fax: 269-818-1680 Email: techsvcs@vikingcorp.com

1. DESCRIPTION

Viking Early Suppression Fast Response (ESFR) Pendent Sprinkler VK500 is a fast response fusible element type sprinkler designed for early fire suppression. With a 14.0 (202 metric*) nominal K-Factor and special deflector, this sprinkler produces large, high-momentum water droplets in a hemispheric pattern below the deflector. This permits penetration of the fire plume and direct wetting of the burning fuel surface while cooling the atmosphere early in the development of a high-challenge fire.

Viking VK500 ESFR Pendent Sprinklers may be used in the protection of ordinary types of storage. However, they are primarily intended to protect the following types of storage, which tend to produce severe-challenge fires: palletized and solid pile storage and single, double, multiple row, and portable open rack storage (no open-top containers or solid shelves).

Viking ESFR Pendent VK500 Sprinklers provide protection of most common storage materials, including:

- Encapsulated or unencapsulated Class I, II, III, and IV commodities*.
- Cartoned and uncartoned unexpanded plastics*.
- Cartoned and uncartoned expanded plastics*.

*Refer the Approval Charts and Design Criteria on pages 120c-d for cULus Listing and FM Approval requirements that must be followed.

In addition, some storage arrangements of rolled paper, aerosols, and rubber tires may be protected by Viking ESFR Pendent Sprinkler VK500.

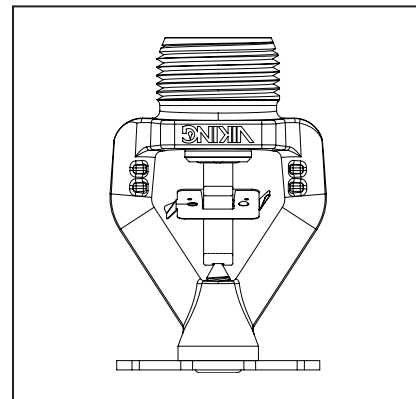

2. LISTINGS AND APPROVALS



cULus Listed: Category VNWH



FM Approved: Class 2008

NYC Approved: MEA 89-92-E, Volume 18



VdS Approved: Certificate G4010001



CE Certified: Standard CUAP11.03/03, EC-certificate of conformity 1725-CPD-H0005, ETA-10/0306

The 10284 and 11350, VK500, ESFR Pendent Sprinkler Assembly conforms to the provision of CUAP11.03/03 standard. CUAP11.03/03 approvals are provided by: FM Approvals Ltd. 1 Windsor Dials Windsor, Berkshire, UK. SL4 1 RS

Approval Certificate No. issued December 20, 2010.

NOTE: Other International approval certificates are available upon request.

Refer Approval Chart 1 and Design Criteria on page 120c for cULus Listing requirements that must be followed, and refer to Approval Chart 2 and Design Criteria on page 120d for FM Approval requirements that must be followed.

3. TECHNICAL DATA

Specifications:

Available since 2000.

Minimum Operating Pressure: Refer to NFPA 13 or FM Global Loss Prevention Data Sheets.

Maximum Working Pressure: 175 psi (12 bar). Factory tested hydrostatically to 500 psi (34.5 bar).

Thread size: 3/4" (20 mm) NPT

Nominal K-Factor: 14.0 U.S. (202 metric**)

**Metric K-factor measurement shown is when pressure is measured in bar. When pressure is measured in kPa, divide the metric K-factor shown by 10.0.

Overall Length: 2-7/8" (73 mm)

Deflector Diameter: 1-3/4" (44.5 mm)

Material Standards:

Frame Casting: Brass UNS-C84400

Deflector: Phosphor Bronze UNS-C51000

Viking Technical Data may be found on
The Viking Corporation's Web site at
<http://www.vikinggroupinc.com>.
The Web site may include a more recent
edition of this Technical Data Page.

	TECHNICAL DATA	ESFR PENDENT SPRINKLER VK500 (K14.0)
---	-----------------------	---

The Viking Corporation, 210 N Industrial Park Drive, Hastings MI 49058

Telephone: 269-945-9501 Technical Services: 877-384-5464 Fax: 269-818-1680 Email: techsvcs@vikingcorp.com

Seat for Sprinkler 11350: Stainless Steel UNS-S31603

Seat and Insert Assembly for Sprinkler 10284: Copper UNS-C11000 and Stainless Steel UNS-S30400

Belleville Spring Sealing Assembly: Nickel Alloy, coated on both sides with PTFE Tape

Compression Screw: Stainless Steel UNS-S31603

Trigger and Support: Stainless Steel UNS-S31600

Fusible Element Assembly: Beryllium Nickel, coated with black acrylic paint.

Ejector Spring (Sprinkler Base Part No. 11350 only): 17-7 Stainless Steel

Ordering Information: (Also refer to the current Viking price list.)

Order ESFR Pendent Sprinkler VK500 by first adding the appropriate suffix for the sprinkler finish and then the appropriate suffix for the temperature rating to the sprinkler base part number.

Finish Suffix: Brass = A

Temperature Suffix: 165 °F (74 °C) = C, 205 °F (96 °C) = E

For example, sprinkler 10284 with a Brass finish and a 165 °F (74 °C) temperature rating = Part No. 10284AC.

Available Finishes And Temperature Ratings: Refer to Table 1.

Accessories: (Also refer to the “Sprinkler Accessories” section of the Viking data book.)

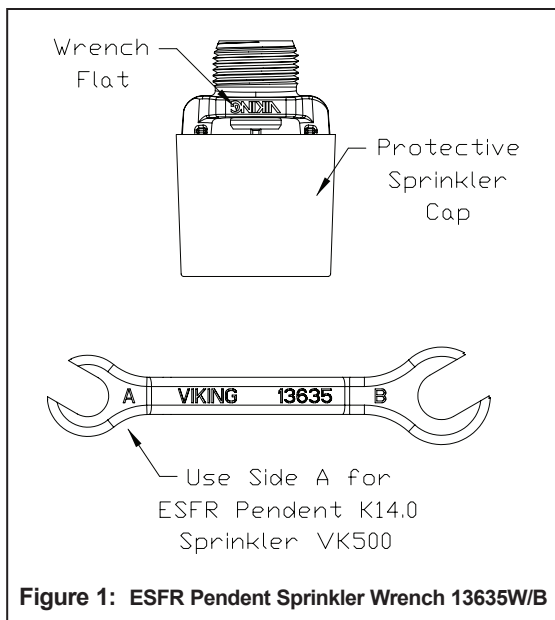
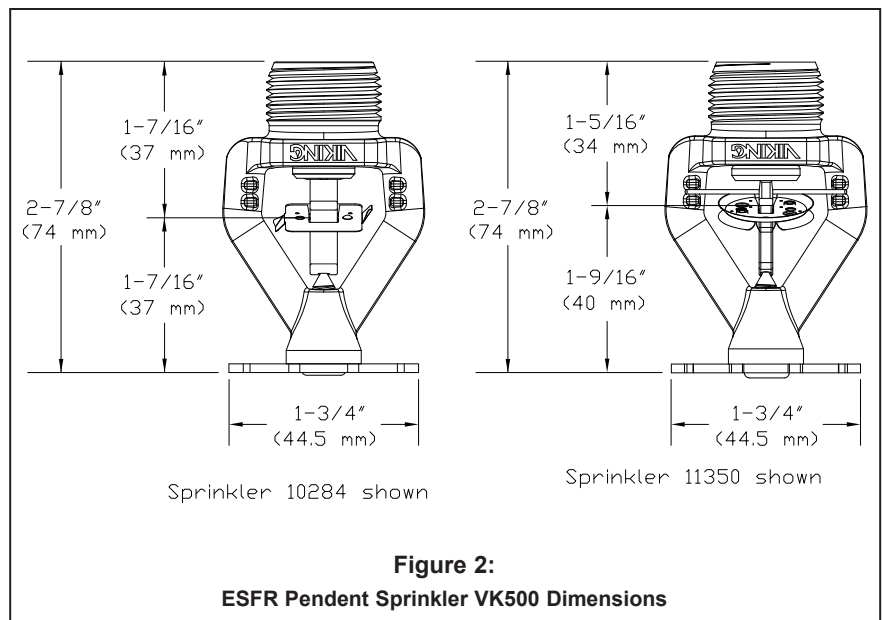

Figure 1: ESFR Pendent Sprinkler Wrench 13635WB



**Figure 2:
ESFR Pendent Sprinkler VK500 Dimensions**

TABLE 1: AVAILABLE SPRINKLER TEMPERATURE RATINGS AND FINISHES

Sprinkler Temperature Classification	Sprinkler Nominal Temperature Rating ¹	Maximum Ambient Ceiling Temperature ²	Frame Paint Color
Ordinary	165 °F (74 °C)	100 °F (38 °C)	None
Intermediate ³	205 °F (96 °C)	150 °F (65 °C)	White

Sprinkler Finish: Brass

Footnotes











¹ The sprinkler temperature rating is stamped on the deflector.

² Based on NFPA-13. Other limits may apply, depending on fire loading, sprinkler location, and other requirements of the Authority Having Jurisdiction. Refer to specific installation standards.

³ The intermediate temperature rating is available for Sprinkler Base Part No. 10284 only.

	TECHNICAL DATA	ESFR PENDENT SPRINKLER VK500 (K14.0)
---	-----------------------	---

The Viking Corporation, 210 N Industrial Park Drive, Hastings MI 49058
Telephone: 269-945-9501 Technical Services: 877-384-5464 Fax: 269-818-1680 Email: techsvcs@vikingcorp.com

Approval Chart 1 (UL) ESFR Pendent Sprinkler VK500 Maximum 175 PSI (12 bar) WWP																			
<table border="1" style="border-collapse: collapse;"> <tr> <td style="padding: 2px;">  Temperature </td> <td style="padding: 2px;"> KEY </td> </tr> <tr> <td style="padding: 2px;">  Finish </td> <td></td> </tr> <tr> <td style="padding: 2px;">  Escutcheon (if applicable) </td> <td></td> </tr> </table>														 Temperature	KEY	 Finish		 Escutcheon (if applicable)	
 Temperature	KEY																		
 Finish																			
 Escutcheon (if applicable)																			
Base Part Number ¹	SIN	NPT Thread Size		Nominal K-Factor		Overall Length		Listings and Approvals ^{3,4} (Refer also to Design Criteria below.)											
		Inches	mm	U.S.	metric ²	Inches	mm	cULus ⁵	NYC ⁶	VdS	LPCB	CE ⁷							
10284	VK500	3/4"	20 mm	14.0	--	2-7/8	73	A1, B1	A1	--	--	A1, B1	--						
11350	VK500	3/4"	20 mm	--	202	2-7/8	73	--	A1	A1	--	A1, B1	--						
Approved Temperature Ratings A - 165 °F (74 °C) B - 205 °F (96 °C)							Approved Finish 1 - Brass												
Footnotes																			
¹ Base part number shown. For complete part number, refer to the price list. ² Metric K-Factor measurement shown is when pressure is measured in bar. When pressure is measured in kPa, divide the metric K-Factor shown by 10.0. ³ This chart shows listings and approvals available at the time of printing. Other approvals may be in process. ⁴ Refer to the latest standards of NFPA 13 and the latest VdS standards. ⁵ Listed by Underwriters Laboratories Inc. for use in the U.S. and Canada. ⁶ Accepted for use, City of New York Department of Buildings, MEA 89-92-E, Vol. 18. ⁷ CE Certified, Standard CUAP11.03/03, EC-certificate of conformity 1725-CPD-H0005, ETA-10/0306.																			

DESIGN CRITERIA (UL) (Also refer to Approval Chart 1 above.)
<p>cULus Listing Requirements:</p> <p>ESFR Pendent Sprinkler 10284 is cULus Listed as indicated in Approval Chart 1 for installation in accordance with the latest appropriate NFPA standards (including NFPA 13) for ESFR Pendent K14.0 (202) Sprinklers, for:</p> <ul style="list-style-type: none"> • Protecting rack storage of certain specified materials up to 35 ft (10.7 m) high in buildings with 40 ft (12.2 m) high ceilings with NO in-rack sprinklers. • NFPA 13 indicates the following for ESFR pendent sprinklers having a 14.0 nominal K-Factor: Position the <u>deflector</u> a maximum of 14" (356 mm) and a minimum of 6" (152 mm) below the ceiling. • The minimum area of coverage allowed per sprinkler is 64 ft² (5.8 m²) per NFPA 13. <p>Maximum Roof or Ceiling Slope: 2 in 12 (167 mm/m or 9.5 degrees).</p> <p>Sprinkler Position: Approved for use only in the pendent position. Align the deflector parallel with the ceiling or roof.</p> <p>System Type: Wet systems only.</p> <p>Deflector Distance from Walls: At least 4" (102 mm) from walls, and no more than one-half the allowable distance permitted between sprinklers.</p> <p>Clearance from Deflector to Top of Storage: At least 36" (914 mm).</p> <p>Maximum Distance Between Sprinklers: The maximum area of coverage allowed per sprinkler is 100 ft² (9.3 m²)**. <ul style="list-style-type: none"> • For buildings over 30 ft (9.1 m) high, spacing between sprinklers and/or branch lines must be from 8 to 10 ft (2.4 to 3.1 m)**. • For building heights up to 30 ft (9.1 m), the spacing allowed between sprinklers and/or branch lines is 8 to 12 ft (2.4 to 3.7 m), provided the area covered per sprinkler does not exceed the maximum 100 ft² (9.3 m²) allowed**. **Refer to the Installation Standards for permissible deviations from the maximum sprinkler spacing rules above, to eliminate obstructions created by trusses and bar joists when using ESFR sprinklers. </p> <p>Minimum Area of Coverage: The minimum area of coverage allowed per sprinkler is 64 ft² (5.8 m²).</p> <p>Note: If the ceiling is beam and girder or panel construction, locate sprinklers in the bays rather than under the beams.</p>
<p>IMPORTANT: Always refer to Bulletin Form No. F_091699 - Care and Handling of Sprinklers. Viking ESFR Pendent Sprinklers are to be installed in accordance with the latest edition of Viking technical data, the latest standards of VdS, NFPA, and any other Authorities Having Jurisdiction, and also with provisions of governmental codes, ordinances, and standards whenever applicable.</p>

	TECHNICAL DATA	ESFR PENDENT SPRINKLER VK500 (K14.0)
---	-----------------------	---

The Viking Corporation, 210 N Industrial Park Drive, Hastings MI 49058
Telephone: 269-945-9501 Technical Services: 877-384-5464 Fax: 269-818-1680 Email: techsvcs@vikingcorp.com

Approval Chart 2 (FM) Quick Response Pendent Sprinkler VK500 Maximum 175 PSI (12 bar) WWP								
								KEY Temperature Finish Escutcheon (if applicable)
Base Part Number ¹	SIN	NPT Thread Size		Nominal K-Factor		Overall Length		FM Approvals ^{3,4} (Refer also to Design Criteria below.)
		Inches	mm	U.S.	metric ²	Inches	mm	
10284	VK500	3/4"	20 mm	14.0	--	2-7/8	73	A1, B1
11350	VK500	3/4"	20 mm	--	202	2-7/8	73	A1, B1
Approved Temperature Ratings A - 165 °F (74 °C) B - 205 °F (96 °C)							Approved Finish 1 - Brass	
Footnotes								
¹ Base part number shown. For complete part number, refer to the price list. ² Metric K-Factor measurement shown is when pressure is measured in bar. When pressure is measured in kPa, divide the metric K-Factor shown by 10.0. ³ This chart shows the FM Approvals available at the time of printing. Other approvals may be in process. ⁴ FM Approved as a quick response pendent Non-Storage sprinkler and also FM Approved as a quick response pendent Storage sprinkler. Refer to Design Criteria below.								

DESIGN CRITERIA - FM (Also refer to Approval Chart 2 above.)
<p>FM Approval Requirements:</p> <ol style="list-style-type: none"> Sprinkler VK500 is FM Approved as a quick response pendent Storage sprinkler as indicated in the FM Approval Guide. <ul style="list-style-type: none"> For specific application and installation requirements, reference the latest applicable FM Loss Prevention Data Sheets (including Data Sheets 2-0 and 8-9). Sprinkler VK500 is also FM Approved as a quick response pendent Non-Storage sprinkler as indicated in the FM Approval Guide. <ul style="list-style-type: none"> For specific application and installation requirements, reference the latest applicable FM Loss Prevention Data Sheets (including Data Sheet 2-0). <p>FM Global Loss Prevention Data Sheets contain guidelines relating to, but not limited to: minimum water supply requirements, hydraulic design, ceiling slope and obstructions, minimum and maximum allowable spacing, and deflector distance below the ceiling.</p> <p>NOTE: The FM installation guidelines may differ from cULus and/or NFPA criteria.</p>
<p>IMPORTANT: Always refer to Bulletin Form No. F_091699 - Care and Handling of Sprinklers. Viking ESFR Pendent Sprinklers are to be installed in accordance with the latest edition of Viking technical data, the latest applicable FM Global Loss Prevention Data Sheets (including 2-0 and 8-9), the latest standards of VdS, NFPA, and any other Authorities Having Jurisdiction, and also with provisions of governmental codes, ordinances, and standards whenever applicable.</p>



TECHNICAL DATA

ESFR PENDENT SPRINKLER VK500 (K14.0)

The Viking Corporation, 210 N Industrial Park Drive, Hastings MI 49058

Telephone: 269-945-9501 Technical Services: 877-384-5464 Fax: 269-818-1680 Email: techsvcs@vikingcorp.com

Sprinkler Wrenches:

- A. Part No. 13635W/B (double-ended wrench - Use Side A. Side B is for use with K25.2 ESFR Pendent Sprinkler VK510) Available since 2006.
- B. Part No. 10285W/B (no longer available)

Sprinkler Cabinet:

Twelve-head capacity: Part No. 01725A (available since 1971)

4. INSTALLATION

WARNING: Viking sprinklers are manufactured and tested to meet rigid requirements of the approving agency. The sprinklers are designed to be installed in accordance with recognized installation standards. System design must be based on ESFR design guidelines described in the latest edition of Viking technical data, applicable FM Global Loss Prevention Data Sheets, the latest NFPA Standards, the latest standards of (VdS) Schadenverhütung, the Authorities Having Jurisdiction, and also with the provisions of governmental codes, ordinances, and standards whenever applicable. Deviation from the standards or any alteration to the sprinkler after it leaves the factory including, but not limited to: painting, plating, coating, or modification, may render the sprinkler inoperative and will automatically nullify the approval and any guarantee made by The Viking Corporation.

- A. Sprinklers must be handled with care. They must be stored in a cool, dry place in their original shipping container. Never install sprinklers that have been dropped or damaged in any way. Such sprinklers should be destroyed immediately. NOTE: Wet pipe systems must be provided with adequate heat.
- B. The sprinklers must be installed after the piping is in place to prevent mechanical damage. Before installing, be sure to have the appropriate sprinkler model and style, with the correct orifice size, temperature rating, and response characteristics.
- C. With the sprinkler contained in the plastic protective cap, apply a small amount of pipe-joint compound or tape to the male threads only, while taking care not to allow a build-up of compound in the sprinkler orifice.
- D. **Use ONLY sprinkler wrench 10285W/B or 13635W/B (shown in Figure 1) for installing ESFR Sprinkler VK500! With the sprinkler contained in the protective cap, install the sprinkler onto the piping by applying the sprinkler wrench to the sprinkler wrench flats only, while taking care not to damage the sprinkler operating parts.**
 - DO NOT use any other type of wrench, as this could damage the unit.
 - DO NOT use the sprinkler deflector or fusible element to start or thread the sprinkler into a fitting.
 - DO NOT exceed 50 ft. lbs. of torque (hand tight, plus approximately two full turns with the wrench) to install these sprinklers. Higher levels of torque may distort the sprinkler inlet with consequent leakage or impairment of the sprinkler.
- E. After installation, the entire sprinkler system must be tested. The test must be conducted to comply with the Installation Standards. Make sure the sprinkler has been properly tightened. If a thread leak occurs, normally the unit must be removed, new pipe-joint compound or tape applied, and then reinstalled. This is due to the fact that when the joint seal is damaged, the sealing compound or tape is washed out of the joint. Immediately replace any damaged units, using the special sprinkler wrench only.
- F. **After installation and testing and repairing of all leaks, remove the protective caps from the sprinklers. DO NOT use any type of tool to remove the cap. Remove the cap by hand: turn it slightly and pull it off the sprinkler. When removing caps, use care to prevent dislodging or damaging sprinkler ejector spring and fusible element. THE CAPS MUST BE REMOVED FROM SPRINKLERS BEFORE PLACING THE SYSTEM IN SERVICE!**
- G. System design must be based on ESFR design guidelines described in applicable FM Global Loss Prevention Data Sheets, the latest standards of (VdS) Schadenverhütung, the National Fire Protection Association, and the Authorities Having Jurisdiction. All requirements of recognized sprinkler system design standards apply to systems utilizing Viking ESFR Pendent Sprinklers. **NOTE: Viking recommends installing one style of sprinklers (either pendent or upright) throughout ESFR systems. However, provided the fusible elements are installed within the distance below the ceiling allowed by the installation standards, and when acceptable to the Authority Having Jurisdiction, Viking considers the practice of mixing upright and pendent ESFR sprinklers to be acceptable.**

5. OPERATION

During fire conditions, the heat-sensitive fusible element assembly disengages, releasing the seat and spring assemblies to open the waterway. Water flowing through the sprinkler orifice strikes the sprinkler deflector, forming a uniform spray pattern to suppress the fire.



TECHNICAL DATA

ESFR PENDENT SPRINKLER VK500 (K14.0)

The Viking Corporation, 210 N Industrial Park Drive, Hastings MI 49058

Telephone: 269-945-9501 Technical Services: 877-384-5464 Fax: 269-818-1680 Email: techsvcs@vikingcorp.com

6. INSPECTIONS, TESTS AND MAINTENANCE

NOTICE: The owner is responsible for maintaining the fire protection system and devices in proper operating condition. For minimum maintenance and inspection requirements, refer to the NFPA standard that describes care and maintenance of sprinkler systems. In addition, the Authorities Having Jurisdiction may have additional maintenance, testing, and inspection requirements that must be followed.

- A. The sprinklers must be inspected on a regular basis for corrosion, mechanical damage, obstructions, paint, etc. The frequency of inspections may vary due to corrosive atmosphere, water supplies, and activity around the device.
- B. Sprinklers that have been painted or mechanically damaged must be replaced immediately. Sprinklers showing signs of corrosion shall be tested and/or replaced immediately as required. Installation standards require sprinklers to be tested and, if necessary, replaced after a specified term of service. For Viking ESFR Pendent Sprinklers, refer to the Installation Standards (e.g., NFPA 25) and the Authorities Having Jurisdiction for the specified period of time after which testing and/or replacement is required. Sprinklers that have operated cannot be reassembled or reused, but must be replaced. When replacing sprinklers, use only new sprinklers.
- C. The sprinkler discharge pattern is critical for proper fire protection. Therefore, nothing should be hung from, attached to, or otherwise obstruct the discharge pattern. All obstructions must be immediately removed or, if necessary, additional sprinklers installed.
- D. When replacing existing sprinklers, the system must be removed from service. Refer to the appropriate system description and/or valve instructions. Prior to removing the system from service, notify all Authorities Having Jurisdiction. Consideration should be given to employment of a fire patrol in the affected area.
 1. Remove the system from service, drain all water, and relieve all pressure on the piping.
 2. Using the special sprinkler wrench, remove the old sprinkler and install the new unit. Care must be taken to ensure that the replacement sprinkler is the proper model and style, with the correct orifice size, temperature rating, and response characteristics. A fully stocked spare sprinkler cabinet should be provided for this purpose.
 3. Place the system back in service and secure all valves. Check the replaced sprinklers and repair all leaks.
- E. Sprinkler systems that have been subject to a fire must be returned to service as soon as possible. The entire system must be inspected for damage and repaired or replaced as necessary. Sprinklers that have been exposed to corrosive products of combustion, but have not operated, should be replaced. Refer to the Authorities Having Jurisdiction for minimum replacement requirements.

7. AVAILABILITY

The Viking Model VK500 Sprinkler is available through a network of domestic and international distributors. See The Viking Corporation web site for the closest distributor or contact The Viking Corporation.

8. GUARANTEE

For details of warranty, refer to Viking's current list price schedule or contact Viking directly.