

AECAS

CAPACITIVE LEVEL SWITCH

CAPACITIVE LEVEL SWITCH

AECAS level switch is a capacitive level sensor for level measurement of conductive liquid, nonconductive liquid, granulated materials with solid particles, adhesive and acid/basic liquids. When a material comes between electrode rod and tank wall, a capacitance change occurs and when this change exceed adjustment threshold, contact output is delivered.

Designed for difficult process conditions. Refrigerated models can be manufactured for high temperature and pressure conditions. Calibrations of triggering point and relay operation range can be performed by the user under workplace conditions. It can be connected horizontally or vertically.

Application Areas

Liquid tanks, food machines, cooling liquid tanks, shipping, glycol tanks, brine, waste water tanks.

Oil tanks, CO2 liquid tanks, high temperature tanks, non-conductive liquids.

Grain stores, cement, sand feed, flour, milk powder, organic and plastic granule.

Technical Specifications

Measurable Material	Conductive liquids, refrigerant non-conductive liquids Solid particulate materials Adhesive and acid / basic liquids
Supply	24 VDC
Output	1 NANK x5 A/250VAC Relay
Min.Di-Electric Constant	1,6 ϵ_r
Connection Material	304 Stainless Steel Opt. 316 Stainless Steel
Isolation Material	PTFE, PFA Opt. Peek, Ceramik
Housing Material	PBT (Std.) Opt. Aluminium Injection, Stainless Steel
Working Pressure	-1...100 bar (Depending on the model.)
Working Temperature	(-) 40 / (+150 °C Depending on the model) 200°C with cooling apparatus. (Peek Isolator 230°C Ceramic Isolator 400°C
Ambient Temperature	(-) 20...(+) 60°C
Display	Power LED ve Contact LED
Isolation	Max. 500V
Power Consumption	Max. 1 W
Electrical Connection	Connector
Protection Class (EN60529)	PBT - IP 66, Aluminium, Stainless Steel IP 65
Test	EMC, Low Voltage
Max. Tensile Force	Max. 40 NM
Weight	285 gr. for AECAS 101

AECAS-CAPACITIVE LEVEL SWITCH

AECAS 101 / 102 / 103 / 107-AECAS 202 / 203 / 204 / 205-AECAS 301 / 304 / 305 / 30D / 30S-AECAS 408A / 408B / 408P / 408T

Advantages

- Optionally high temperature resistant design.
- Easy to assemble and adjust sensitivity.
- No cleaning required.
- Foam, splashes and not affected by coating the probe.
- Can be connected in reverse.

Working Principle:

Capacitance definition, assuming two parallel conductive plates are used;

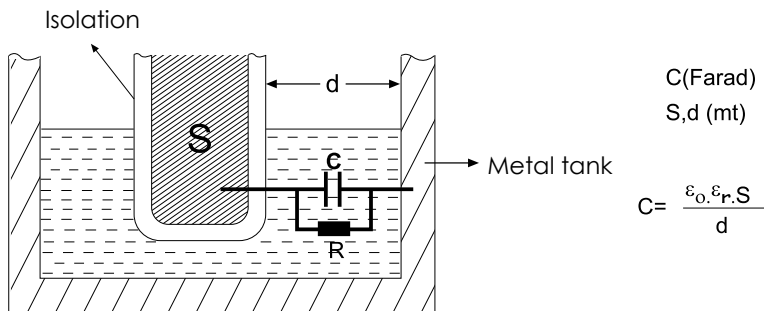

However, there are scarcely any sensor type which this definition can be practically utilized. Above Formula can no longer be reliable especially when residual areas increase due to large distance (d) (which is usually the case). Thus, measuring impedance for distance measurements give more accurate results than capacitance measurement.

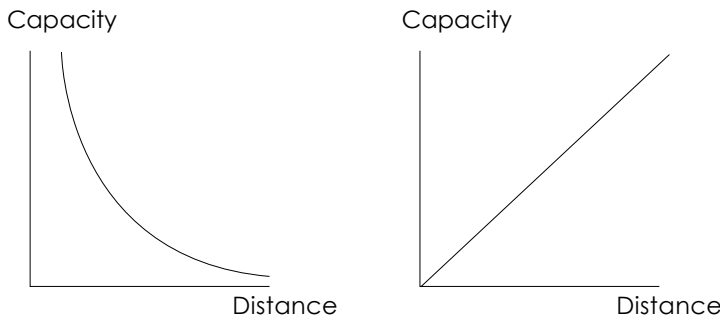

Impedance definition $Z = R + jL\omega + (jC\omega)^{-1}$ R is defined as real component and represent ambient conductivity.

$jL\omega$ second component is defined as inductive reactance. This component is present even if we perform capacitive measurement. However we neglect this. Since we evaluate results based on electrostatic properties of the environment, no error will occur. Resulting impedance definition is

$$Z = R + (jC\omega)^{-1}$$

Measurement is made by charge transfer in our capacitive sensors. Total impedance is defined as $Z = V / I$. I (current) $I = Q/t$
 Q (Coulomb)
 T (sec)

Capacitive reactance we desire to measure is $(jC\omega)^{-1}$. Meaning that charge and impedance have the same phase. To summarize, charge transferred to medium is directly proportional with capacitive reactance. For sensors manufactured as coaxial;

- a: Central electrode radius
- b: Outer screen radius
- L: length

$$C = \frac{2 \cdot \pi \cdot \epsilon_0 \cdot \epsilon_r}{\ln(b/a)} \cdot L$$

Impedance is calculated by this definition

Excitation applied between 10KHz–250KHz based on length for all our models. ($\omega = 2\pi f$) Linearity error that may be caused by conductivity component (R) effect is prevented by electronic circuit design and mechanical design. Reduced to a level lower than 1ppm, acceptable as zero.

Process Pressure / Temperature Chart

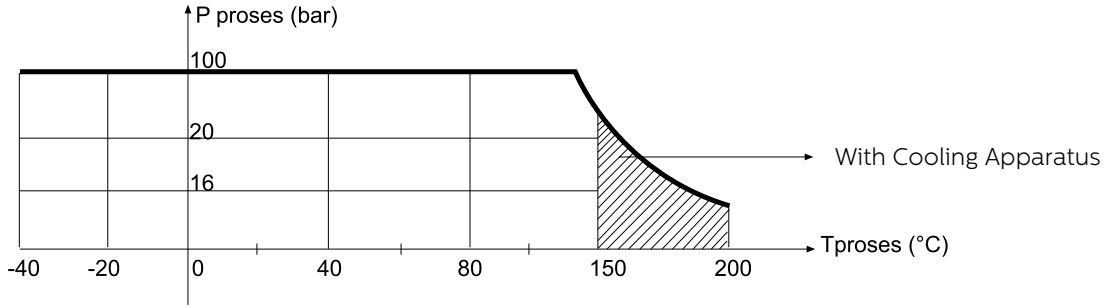

Environment Pressure / Temperature Chart

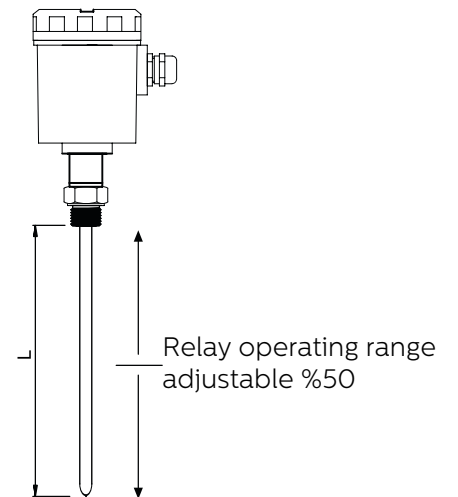
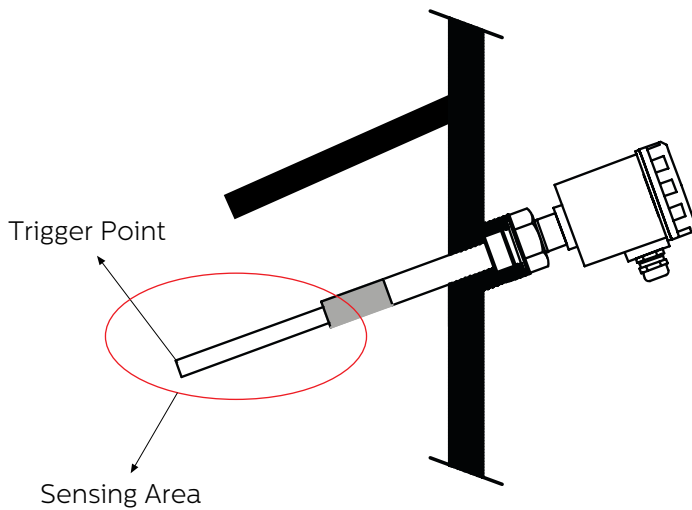
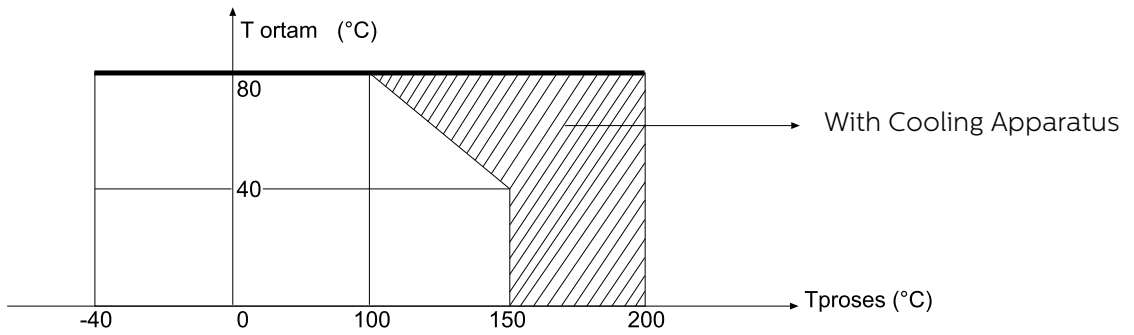

Application Sample

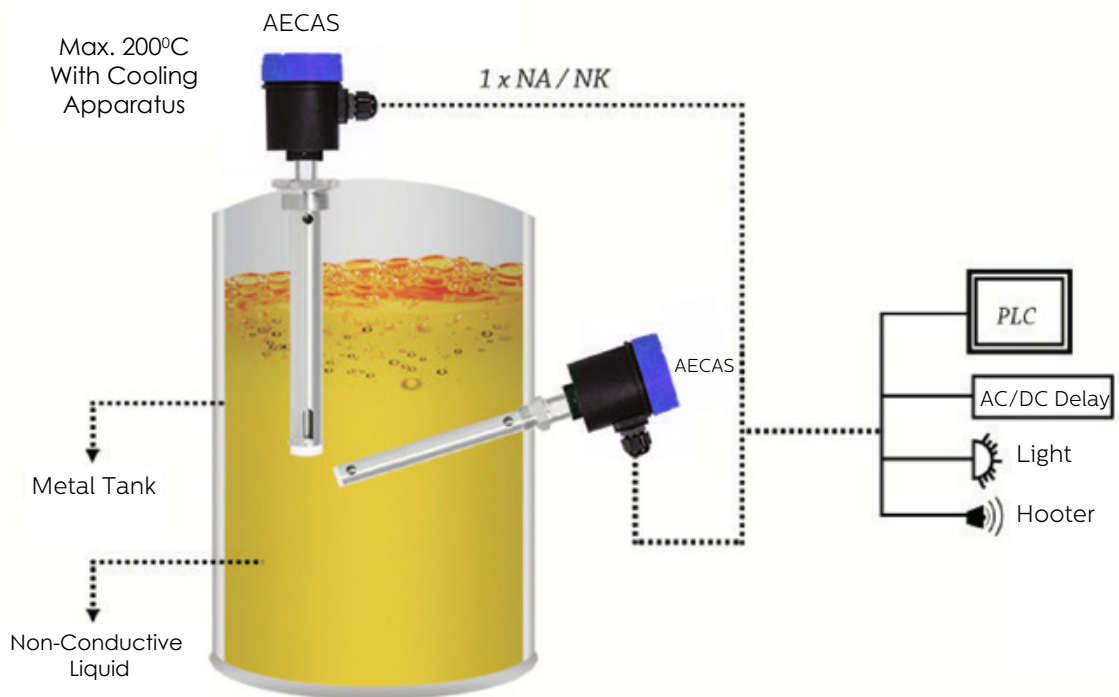
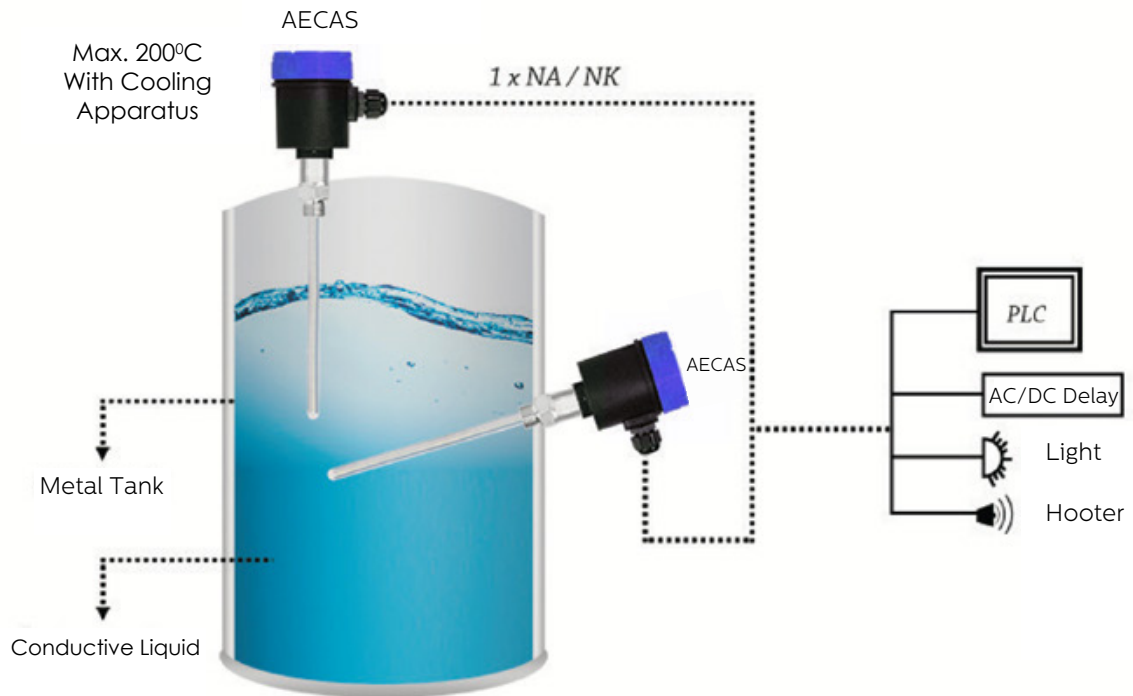

Application Examples :

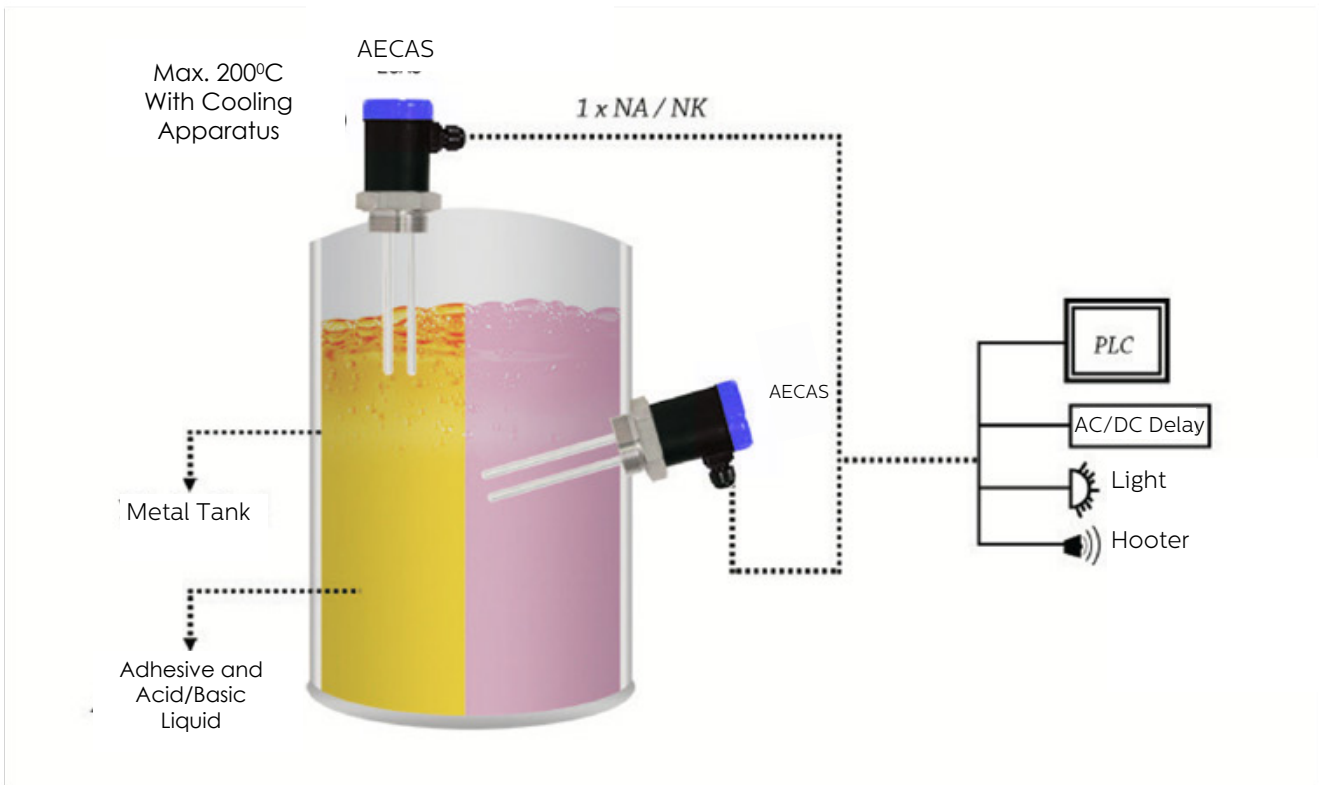
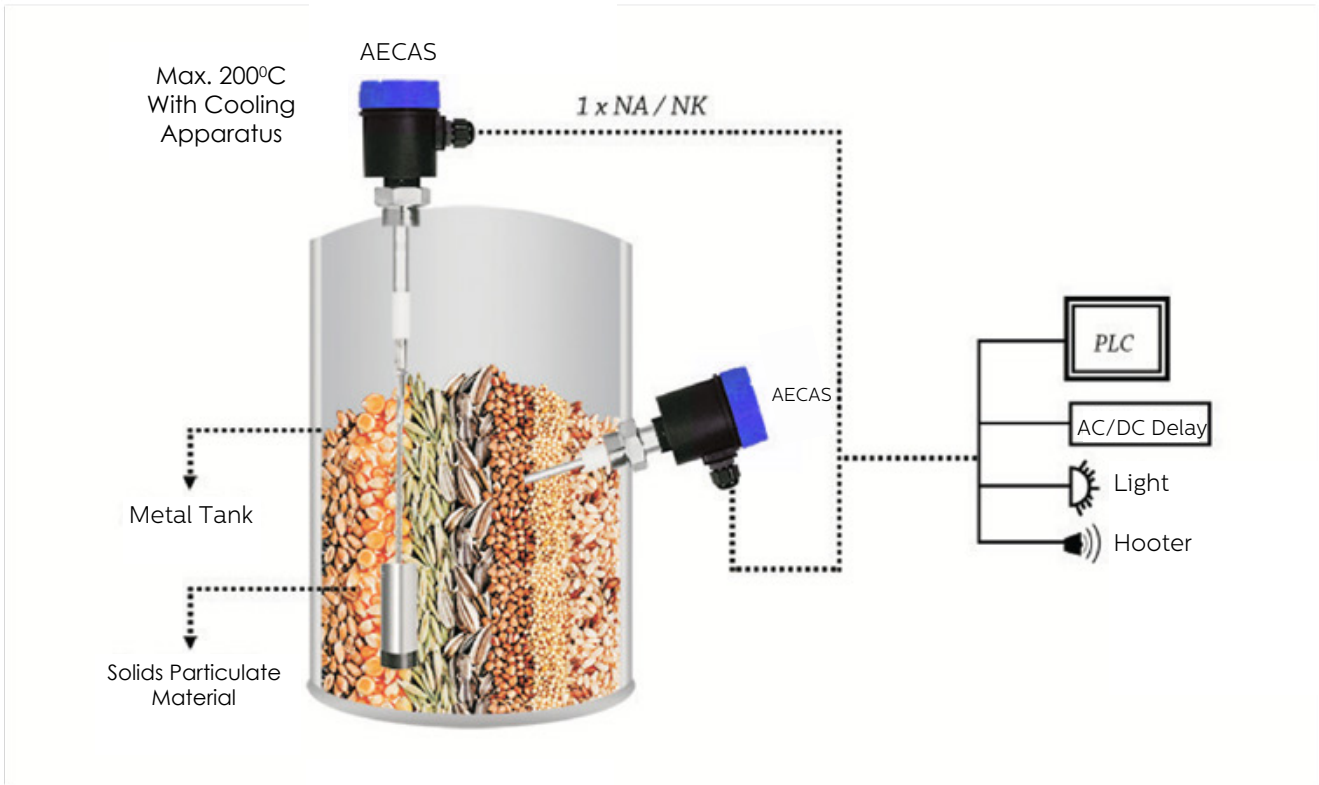

Parts:

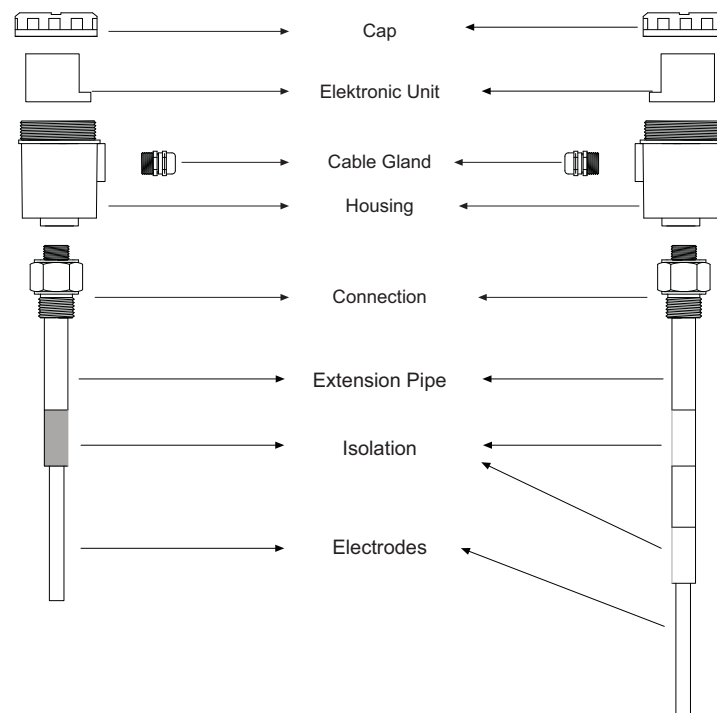
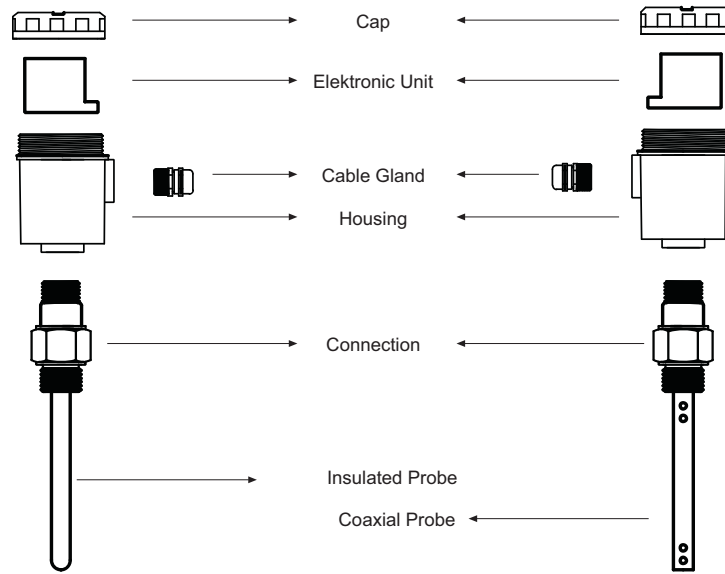

Housing :

TYPE	MATERIALS	PROTECTION CLASS	TEMPERATURE (°C)	SIZE a x b x c (mm)
B10p	Plastic (PBT)	IP 65 / IP 67	-40...+150	96 x 77
B10x	Aluminium	IP 65	-40...+150	96 x 77
B101x	Stainless Steel	IP 65	-40...+150	108 x 79

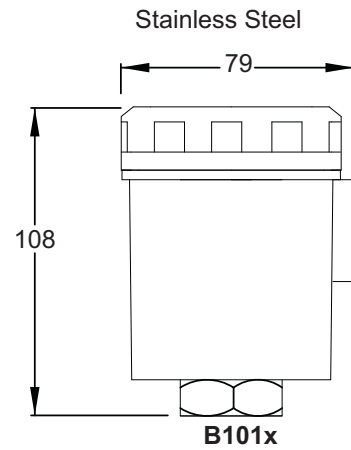
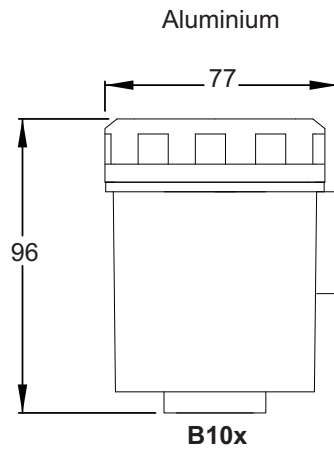
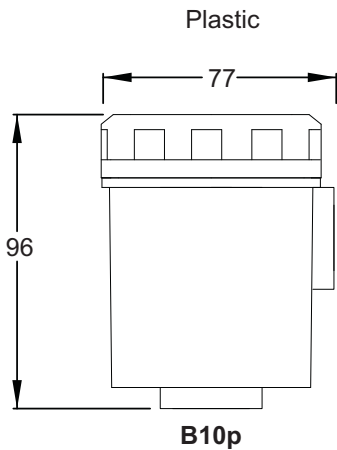

Mechanical Connection :

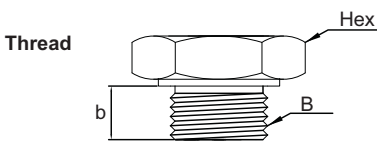

(ISO228-1)

Dimension B	Hex [mm]	Screw Length b [mm]
1/2" BSP	27	14
3/4" BSP	32	14
1" BSP	41	23
1 1/4" BSP	51	23
1 1/2" BSP	60	23
2" BSP	70	23

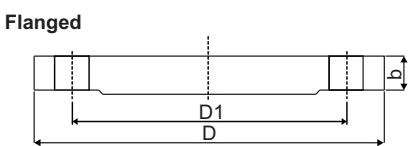

(ISO1092-1)

PN 16	D (mm)	D1 (mm)	b (mm)
DN25	165	85	16
DN50	165	115	18

(ISO1092-1)

PN 40	D (mm)	D1 (mm)	b (mm)
DN25	115	85	18
DN32	140	100	20
DN50	165	125	20
DN80	200	160	20
DN100	235	190	24

(ANSI B16.5)

PN 40	D (mm)	D1 (mm)	b (mm)
DN50	152,4	121	19
DN80	190,5	152,4	23,8
DN100	228,6	157,2	23,8

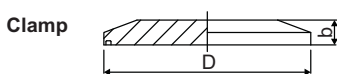

(ISO2852)

Dimension	Çap D (mm)	b (mm)
DN32	50,5	32
DN50	64	50
DN65	91	65

Electrical Connection :

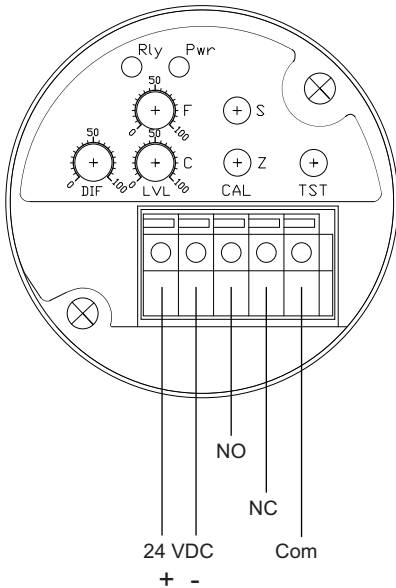

Indification and Calibtarian :

- * **RlyLED:** "Relay active" during normal operation; means operation continues during calibration. Flashes continuously in normal operation mode –if relay is active– and blinks in calibration mode. It is red colored.
- * **PwrLED:** Means there is no sensor failure during normal operation, and means "desired measurement values are saved in memory" during calibration. Operates by flashing. If light is continuous, it indicates failure. It is gren colored.
- * **CAL - S Button:** Used to acquire "High Level-span-"value during calibration.
- * **CAL - Z Button:** Used to acquire "Low Level-zero-"value during calibration.
- * **TST Button:** During normal operation, functions as "Relay Test"; during calibration, performs "saving to nonvolatile memory" of Zero-Span, the values previously acquired by S and Z button, function.
- * **LVL - C Pot:** Adjusts relay triggering point between Zero-Span values.
- * **LVL - F Pot:** Performs as "fine tuning" for triggering point. Adjustment field is equal to +/- 5% of the point adjusted by "C Pot" (total 10%).
- * **DIF Pot:** Adjusts "Release" level of the relay activated by "C/F Pot". Highest adjustable value is equal to half (50%) of the operation region specified by "Z and S". Meaning that, when DIF Pot is at 100% and relay is pulled, the level to release it shall be reduced as half of the total scale.

Electronic Unit with Cable:

Electronic unit and sensor component can be separated by a cable protected against exterior conditions for easy calibration on site. Cable provides easy assembly for user by its property not affecting capacitive measurement.

Sample Model:

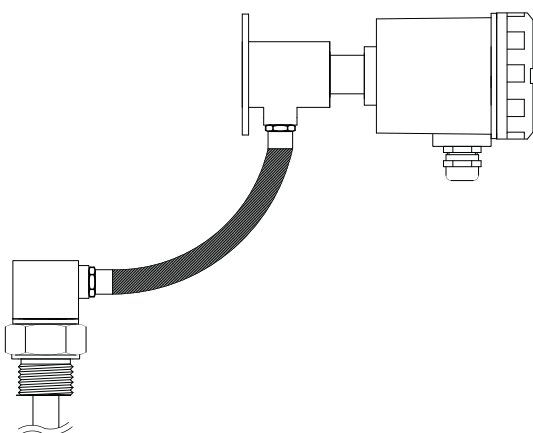

Cooling Equipment:

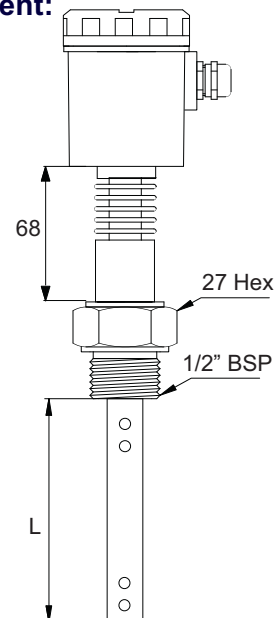

Sample Models:

	Model Measuring Range	Probe	Process Pressure/ Temperature	
CONDUCTIVE LIQUIDS	AECAS 101 L=250mm.(Std) Max. 4 m.		-1...+100 bar -40...+150°C	
	AECAS 102 L=250mm.(Std) Max. 4 m.		Fully Insulated Coaxial Probe Insulated Tank	-1...+100 bar -40...+150°C
	AECAS 103 L=250mm.(Std) Max. 1 m.		Fully Insulated Coaxial Probe Insulated Tank	-1...+100 bar -40...+150°C
	AECAS 107 L=1mt.(Std) Max. 32 m.		Fully Insulated Probe Metal Tank	-1...+60 bar -40...+150°C

Sample Models:

AECAS 101

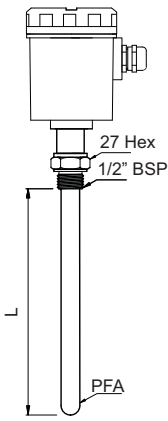

L=250 mm (Std.) , Max 4 m.

AECAS 102

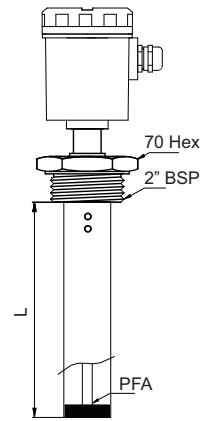

L=250 mm (Std.) , Max 4 m.

AECAS 103

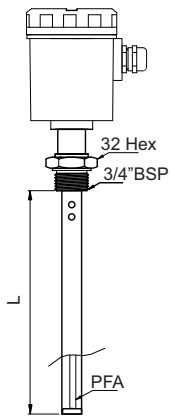

L=250 mm (Std.) , Max 4 m.

AECAS 107

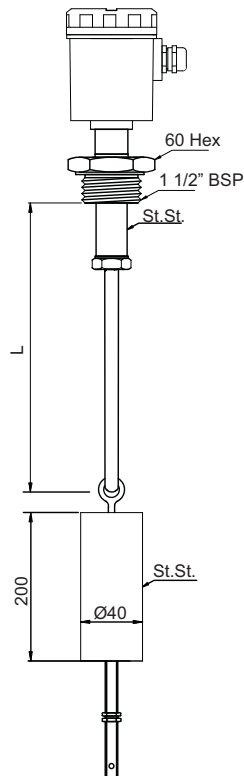

L=1000 mm (Std.) , Max. 16 m.

AECAS 107

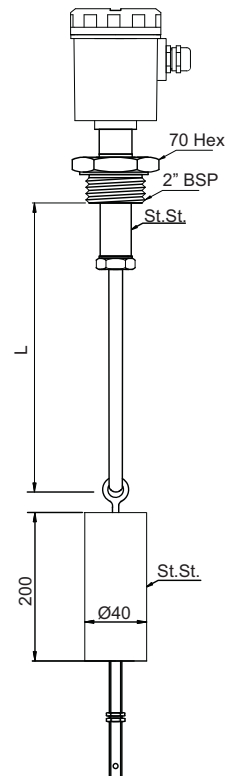

L=1000 mm (Std.) , Max. 32 m.

Sample Models:

	Model Measuring Range	Probe	Process Pressure/ Temperature
NON - CONDUCTIVE LIQUIDS	AECAS 202 L=250mm.(Std) Max. 4 m. 	Partly Insulated Coaxial Probe Metal / Insulated Tank	-1...+100 bar -40...+150°C
	AECAS 203 L=250mm.(Std) Max. 1 m. 	Partly Insulated Coaxial Probe Metal / Insulated Tank	-1...+100 bar -40...+150°C
	AECAS 204 L=1mt.(Std) Max. 32 m. 	Partly Insulated Rope Metal Tank	-1...+60 bar -40...+150°C
	AECAS 205 L=250mm.(Std) Max. 6 m. 	Partly Insulated Rope Metal Tank	-1...+60 bar -40...+150°C

Sample Models:

ECAS 202

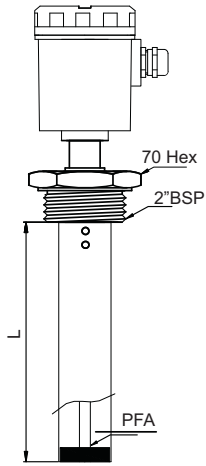

L=250 mm (Std.) , Max. 4 m.

ECAS 203

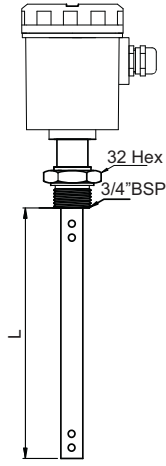

L=250 mm (Std.) , Max 1 m.

ECAS 205

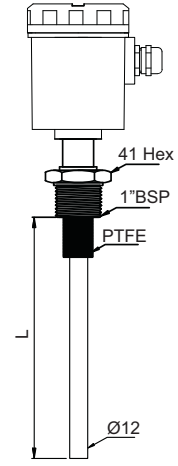

L=250 mm (Std.) , Max 1 m.

ECAS 204

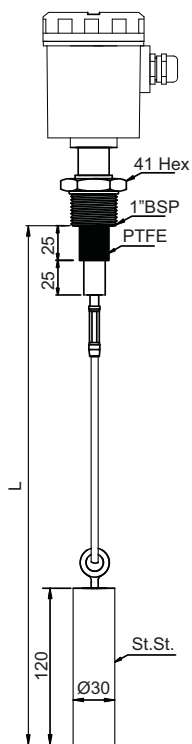

L=1000 mm (Std.) , Max. 10 m.

ECAS 204

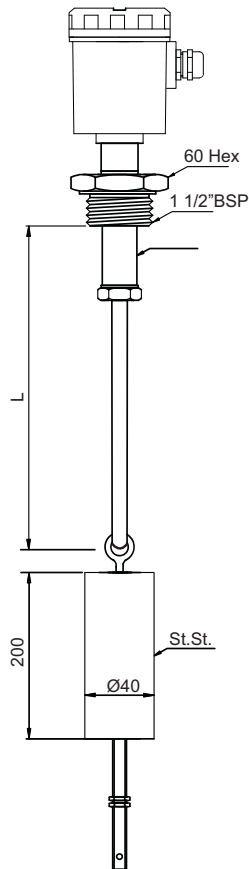





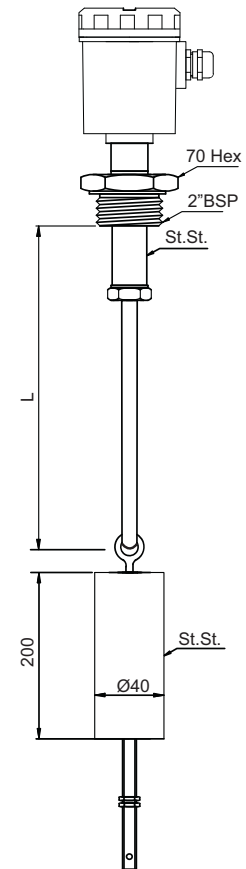

L=1000 mm (Std.) , Max. 16 m.

ECAS 204



L=1000 mm (Std.) , Max. 32 m.

Sample Models:

	Model Measuring Range		Probe	Process Pressure/ Temperature	
SOLIDS PARTICULATE MATERIALS	AECAS 301 L=250mm.(Std) Max. 1 m.		For Antistatic Material	Insulated Probe Metal Tank	-1...+25 bar -40...+150°C
	AECAS 304 L=1mt.(Std) Max. 32 m.			Partly Insulated Rope Metal Tank	-1...+25 bar -40...+150°C
	AECAS 305 L=250mm.(Std) Max. 6 m.			Partly Insulated Probe Metal Tank	-1...+25 bar -40...+150°C
	ECAS 305m L=250mm.(Std) Max. 1 m.				
	AECAS 30D L=380 mm.(Std) Max. 4 m.			Partly Double Insulated Probe Metal / Insulated Tank	-1...+25 bar -40...+200°C
	AECAS 30S L=380 mm.(Std) Max. 4 m.		For High Temperature	Partly Insulated Probe Metal Tank	-1...+25 bar -40...+400°C

Sample Models:

AECAS 301

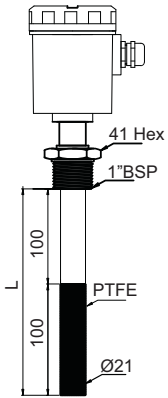

L=250 mm (Std.) , Max.1 m.

For antistatic material

AECAS 305m

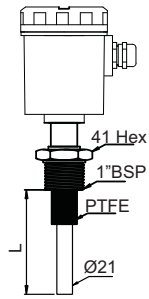

L=250 mm (Std.) , Max.1 m.

AECAS 305

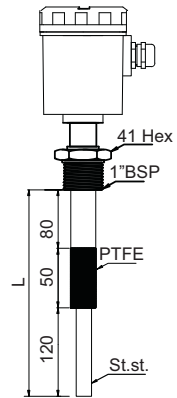

L=250 mm (Std.) , Max. 6 m.

AECAS 304

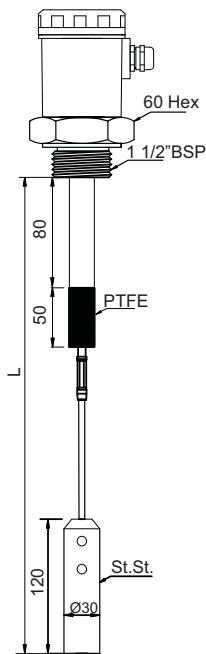

L=1000 mm (Std.) , Max. 32 m.

AECAS 30D

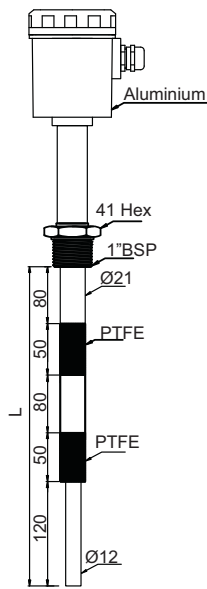

L=380 mm (Std.) , Max. 4 m.

AECAS 30S

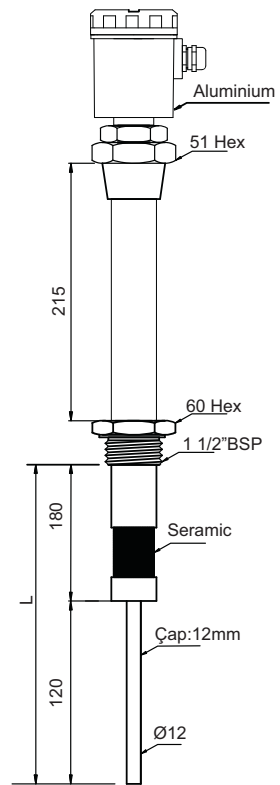

L=380 mm (Std.) , Max. 4 m.

Sample Models:

	Model	Measuring Range	Probe	Process Pressure/ Temperature
ADHESIVE AND ACID / BASIC LIQUIDS	AECAS 408A	Aggressive Liquids L=250mm.(Std)	Double Insulated Probe Metal / Insulated Tank	-1...+100 bar -40...+150°C
	AECAS 408B	Aggressive Liquids L=250mm.(Std)	Partly Insulated Double Probe Metal / Insulated Tank	-1...+60 bar -40...+150°C
	AECAS 408P	Solid Particulate L=250mm.(Std)	Double Probe Metal / Insulated Tank	-1...+25 bar -20...+80°C
	AECAS 408T	Acid/Basic Liquids L=250mm.(Std)	Fully Insulated Double Probe Metal / Insulated Tank	-1...+60 bar -40...+150°C

Sample Models:

AECAS 301

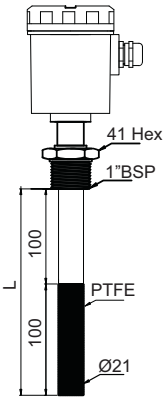

L=250 mm (Std.) , Max. 1 m.

AECAS 305m

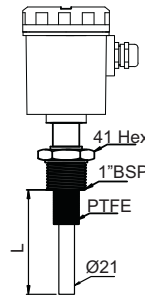

L=250 mm (Std.) , Max. 1 m.

AECAS 305

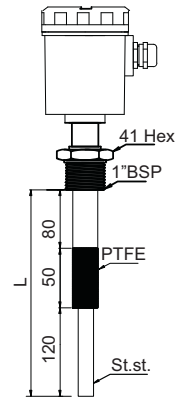

L=250 mm (Std.) , Max. 6 m.

For antistatic material

AECAS 304

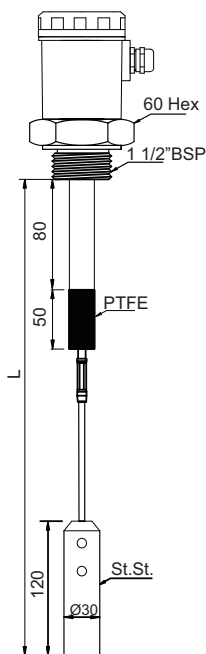

L=1000 mm (Std.) , Max. 32 m.

AECAS 30D

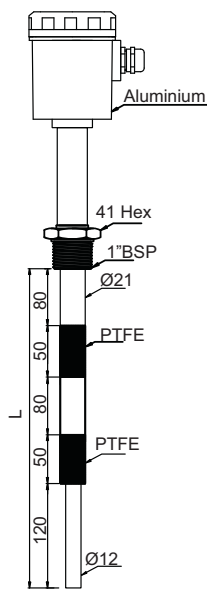

L=380 mm (Std.) , Max. 4 m.

AECAS 30S

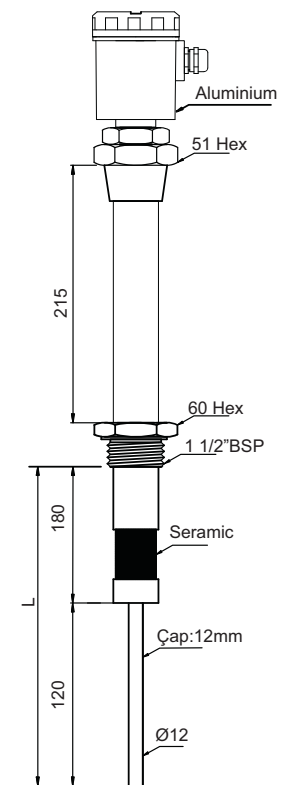

L=380 mm (Std.) , Max. 4 m.

Order Form : Please consider sample models when coding.

1 MODEL AECAS

Conductive Liquids.....1	Solids Particulate Materials.....3
Non-Conductive Liquids2	Adhesive and Acid/Basic Liquids.....4

2 CERTIFICATE

No.....0

3 PROBE TYPE (MAX. LENGHT)

Fully Insulated Probe (Max. 4 m.).....1	Double Insulated Probe..... (Max. 4 m.).....8A
Coaxial Probe, (Max. 4 m.) Ø38.....2	Partly Insulated Double Probe((Max. 6 m.).....8B
Coaxial Probe, (Max. 4 m.) , Ø21.....3	Non Insulated Double Probe(Max. 6 m.) DELRIN.....8P
Partly Insulated Rope Probe (Max. 32 m.)...4	Insulated Double Probe (Max. 4 m.) PTFE.....8T
Partly Insulated Probe , (Max. 6 m.).....5	Double Rope Probe (Max. 32 m.).....9
Partly Insulated Probe , (Max. 1 m.).....5m	Double Insulated Probe (Max. 4 m.).....S
High Temperature (Max. 4 m.).....6	Single Insulated Probe (Max. 4 m.).....D
Complete Insulated Rope Probe (0...32m.)...7	Special Insulated Probe.....x

4 STEM LENGHT

...mm.....0

5 PROCESS TEMPERATURE

150°C Standard0	(-)196°C For Cryocenic Tank2
200°C with Cooling Apparatus1	230°C with Peek Insulated3
	400°C with Ceramic Insulated4

6 CONNECTION

<u>Thread (ISO 228-1)</u>	<u>Clamp (ISO 2852)</u>	<u>ISO Flange (1092-1)</u>	<u>ASA Flange (B16.5)</u>	<u>Special Flange</u>
1/2" BSP.....04	DN25 - PN16 ... 21	DN25 - PN40 ... 26	DN50 - 150lb ... 41	Ø70 Flanged...71
3/4" BSP.....05	DN50 - PN16 ... 23	DN32 - PN40 ... 27	DN80 - 150lb ... 43	Special.....x
1" BSP.....06		DN50 - PN40 ... 28	DN100 - 150lb ... 44	
1 1/2" BSP08		DN80 - PN40 ... 29		
2" BSP.....09		DN100 - PN16 ... 30		
1/2" NPT.....12				
3/4" NPT.....13				

7 OUTPUT

Relay Output.....11	Special.....x
---------------------	---------------

8 HOUSING MATERIAL

Plastic (PBT).....B10p	Stainless SteelB101x
Aluminium.....B10x	Special.....x

9 INSULATION MATERIAL

PTFE.....10	PBT.....14
PEEK.....11	PFA.....17
Seramic.....12	Rubber.....18
Polyamide.....13	FKM.....19
	Special.....x

10 CONNECTION MATERIAL

316 Stainless Steel02	PBT.....14
Brass.....03	PVDF.....15
Delrin.....09	Polypropylene.....16
PTFE.....10	Special.....x

11 OPTIONAL

No...../ 0	Seperable Electronic Unit...../ S
	Wall Apparatus...../ W

SAMPLE

ECAS - 101 - 300mm- 0 - 3 - 06 - 11 - B10x - 11 - 02 / 0 For Cond. Liquid,, L=300mm, 1" BSP, Relay Output, Aluminium Housing

AECAS

CAPACITIVE LEVEL SWITCH



HEAD OFFICE - FACTORY

Atatürk Sanayi Bölgesi Hadımköy Mahallesi Mustafa İnan Caddesi No: 44 Arnavutköy - İSTANBUL
 Tel: +90 212 771 01 45 (pbx) | Fax: +90 212 771 47 27
 info@ayvaz.com | www.ayvaz.com

**Cona
Caserta/Italy**

Tel: +39 0823 187 3988
 rmolaro@ayvaz.com

**Ayvaz Germany
Viernheim/Germany**

Tel: +49 62046014399
 germany@ayvaz.com

**Ayvaz Ukraine
Kiev/Ukraine**

Tel: +380 44 390 57 57
 info@ayvaz.com.ua

**Tricorr
Warsaw/Poland**

Tel: +48 530 030 810
 +48 533 603 335
 tricorr@tricorr.eu

**Ayvaz Azerbaijan
Baku/Azerbaijan**

Tel: +99 (455) 579-84-32
 ahayatov@ayvaz.com

**Ayvaz Egypt
Cairo/Egypt**

Tel: +20 122 819 78 29
 andrew.eid@ayvaz.com

**Ayvaz Gulf
Dubai/U.A.E**

Tel: +971 563550822
 +971 501306871
 mideast@ayvaz.com

**Ayvaz China
Ningbo/China**

Tel: +86 152 5830 7361
 msahin@ayvaz.com

**Ayvaz Kazakhstan LLP
Almaty/Kazakhstan**

Tel: +7 (727) 327 97 57
 info_kz@ayvaz.com

**Ayvaz N
Ispirih/Bulgaria**

Tel: +359 8431 27 32
 office@ayvaz-n.eu

**Ayvaz Serbia
Belgrade/Serbia**

Tel: +381 61 658 70 52
 yakbiyik@ayvaz.com

**Ayvaz Vietnam
HCMC/Vietnam**

ggursoy@ayvaz.com
 Tel: +84 89 8508345

**Ayvaz Americas
Rhode Island/USA**

Tel: +1 401 737 8380
 americas@ayvaz.com