

Bi-Stable Switch

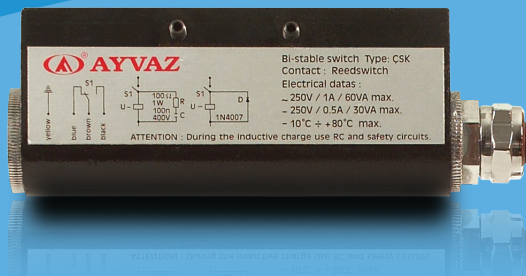

Mono-Stable Switch

LEVEL SWITCH

GENERAL FEATURES

Ayvaz Bi-Stable Switch

Ayvaz Bi-stable Switch is a relay that preserve its switch position after the switch-controller (eg. magnet) is detached. Ayvaz Bi-stable Switch ensures a relay to maintain its position if electrical interruption occurs.

Bi-stable switch is a part of the level controller equipment of MG-33/33S and it is designed to get dry contact when mounted on the side of MG-33/33S's rail/by-pass tubes. Bi-stable Switch has come with 1 meter long cable, ready to be mounted on the level controller where dry contacts are required and it does not require a second control panel.

Bi-stable Switch is activated/deactivated when MG-33/ MG-33S's float passes next to it. By dry contact, it is possible to control high/low level alarms, pump on/off, valve on/off.

Ayvaz Mono-Stable Switch

These are the parts that are mounted on the MG-33 magnetic level indicators, which are mounted on the tanks, to the point where the contact will be made. The magnetic float inside the level indicator gives a dry contact when it reaches the point where the sensing element is connected.

This control system is sealed with Ayvaz double relay level control panel or with a control panel of different brands; pump can receive Start/Stop, High/Low Level alarm, valve can be opened and closed.

Depending on the fluid temperature, metal or plastic sensing element can be selected. A sensing element should be preferred at temperatures up to 80 °C, and a metal detector at temperatures above 80 °C.

MONO / BI-STABLE LEVEL SWITCH

AYVAZ BI-STABLE SWITCH TECHNICAL SPECIFICATIONS

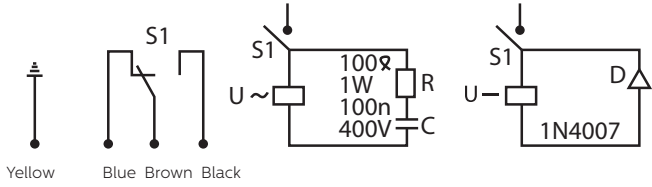

Specifications

250V / 1A / 60VA / AC max
 250V / 0.5A / 30VA / DC max
 -10 °C - +80 °C max

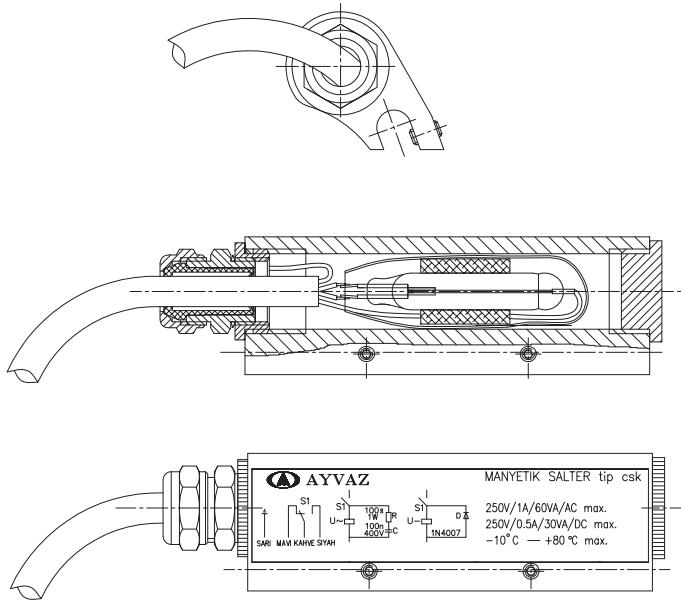

AYVAZ MONO-STABLE SWITCH TECHNICAL SPECIFICATIONS

MONO STABLE SWITCH CONNECTION DIAGRAM

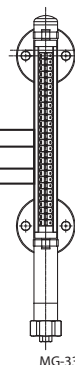
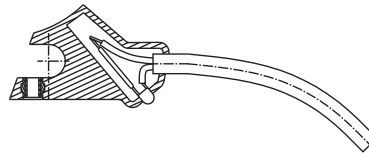
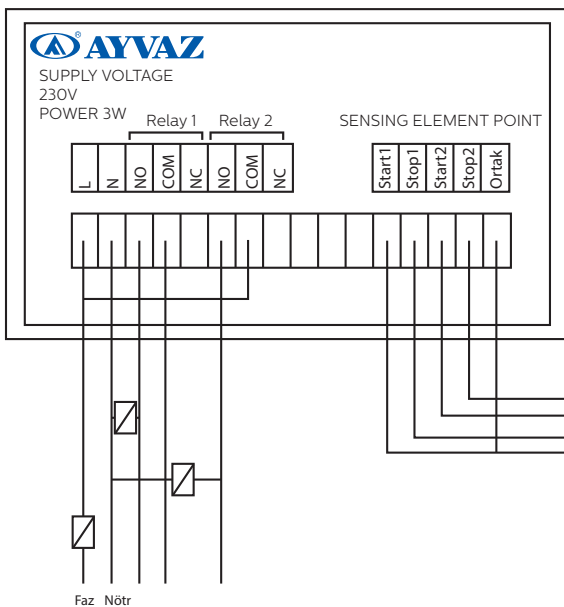

MONO / BI-STABLE LEVEL SWITCH

APPLICATION CHART

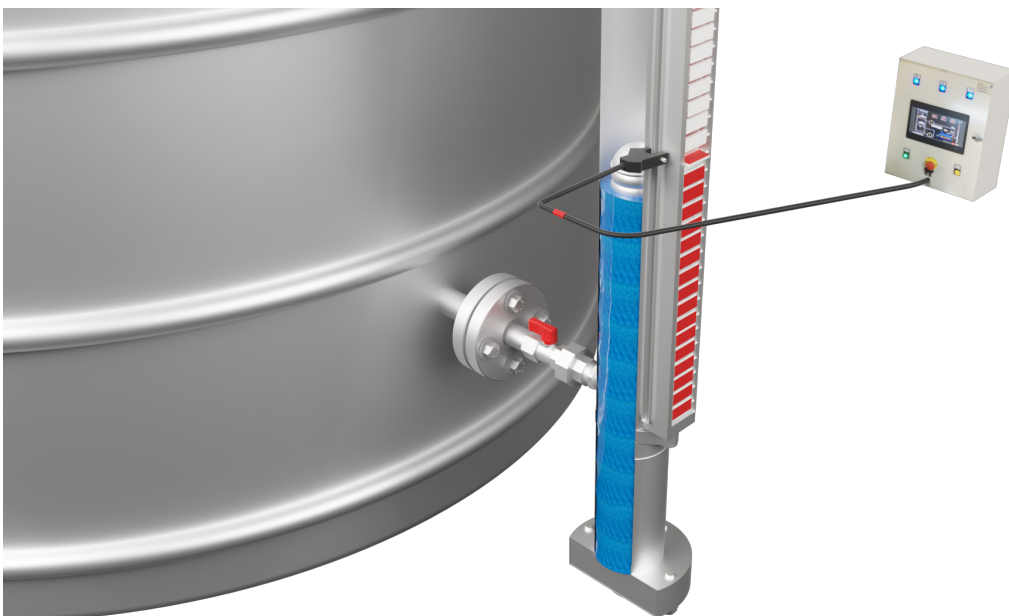



HEAD OFFICE - MAIN FACTORY

Atatürk Sanayi Bölgesi Hadımköy Mahallesi
Mustafa İnan Caddesi No: 44 Arnavutköy - İstanbul
Tel: +90 212 771 01 45 (pbx) | Fax: +90 212 771 47 27
info@ayvaz.com | www.ayvaz.com



Cona
Caserta / Italy
Tel : +39 0823 187 3988
rmolaro@ayvaz.com



Ayvaz Ukraine
Kiev / Ukraine
Tel : +380 44 390 57 57
info@ayvaz.com.ua



Tricorr
Warsaw / Poland
Tel : +48 530 030 810
tricorr@tricorr.eu



Ayvaz Germany
Viernheim / Germany
Tel : +49 62046014399
germany@ayvaz.com



Ayvaz Serbia
Belgrade / Serbia
Tel : +381 61 658 70 52
yakbiyik@ayvaz.com



Ayvaz Azerbaijan
Baku / Azerbaijan
Tel : +99(455)579-84-32
ahayatov@ayvaz.com



Ayvaz Kazakhstan LLP
Almaty / Kazakhstan
Tel : +7 (727) 327 97 57
www.ayvaz.kz



Ayvaz N
Isperih / Bulgaria
Tel : +359 8431 27 32
office@ayvaz-n.eu



Ayvaz Vietnam
HCMC / Vietnam
Tel : +84 89 8508345
ggursoy@ayvaz.com



Ayvaz China
Ningbo / China
Tel : +86 152 5830 7361
msahin@ayvaz.com



Ayvaz Egypt
Cairo / Egypt
Tel : +20 122 819 78 29
andrew.eid@ayvaz.com



Ayvaz Gulf
Dubai / U.A.E.
Tel : +971 563550822
+971 501306871
mideast@ayvaz.com



Ayvaz Americas
Rhode Island
Tel : +1 401 737 8380
americas@ayvaz.com